

**MAGNAGLO®
Magnetic Particles**

The fastest testing
method for ferrous
metals

MAGNAGLO®

**ZYGLO®
Fluorescent
Penetrants**

Provides maximum
reliability and
sensitivity

ZYGLO®

MAGNAFLUX®

A Division of Illinois Tool Works Inc.

SPOTCHECK®

**SPOTCHECK®
Dye Penetrants**

Bright red indications
for portable,
economical
inspections

DARACLEAN®

**DARACLEAN®
Aqueous Cleaners**

Effective and
environmentally safe
cleaners

THE MAGNAFLUX® ADVANTAGE

MAGNAFLUX®

A Division of Illinois Tool Works Inc.

MAGNAFLUX®, a division of Illinois Tool Works Inc., for 70 years has been a leading worldwide supplier of magnetic particle, and dye penetrant inspection equipment and associated chemical products used for nondestructive testing. MAGNAFLUX® has 180 employees worldwide with offices in Glenview, IL; Swindon, England; and Brazil with manufacturing facilities in DeWitt and Manchester, Iowa.

As an Illinois Tool Works (ITW) company, MAGNAFLUX® is part of a family of companies that design and manufacture fasteners, components, assemblies and systems for customers around the world. Through proven business systems and practices, based on teamwork with customers and suppliers alike, the men and women of ITW are creating superior products, solutions and work environments.

MAGNAFLUX's concept, philosophy and performance are based on the idea of selling ideas and experience first, and hardware second. By asking the question, "How might the user obtain the full values of nondestructive testing?," our application and product specialists can propose the equipment and materials which will fulfill all of the user's requirements. To do it right, products and problems must be studied and understood, economic factors evaluated, test methods properly applied or adapted and often new techniques must be developed. Striving to meet our customer's expectations, MAGNAFLUX® is ISO 9001 certified.

MAGNAFLUX® offers a complete line of liquid penetrant inspection, magnetic particle inspection, equipment and accessories, as well as processing materials, all of which are designed specifically for the NDT industry.



AN INDUSTRY LEADER

MAGNAFLUX® solutions are found throughout the world in a wide range of industries and applications, including:

- *Aerospace*
- *Automotive*
- *MRO*
- *Welding*
- *Pipelines*
- *Utilities*
- *Tool Shops*
- *Steel Mills*

WWW.MAGNAFLUX.COM

TABLE OF CONTENTS

THE MAGNAFLUX ADVANTAGE

Product Application Guide3

SPOTCHECK® PENETRANTS

Benefits and Applications4
 Penetrants5
 Cleaners/Removers5
 Developers5
 Kits6
 Specification Conformance Chart6

ZYGLO® PENETRANTS

Benefits and Applications7
 Liquid Penetrant Classification per AMS 26448
 Penetrant Inspection Method8-9
 Water Washable Penetrants10
 Post Emulsifiable Fluorescent Penetrants11
 Water Base Fluorescent Penetrant11
 Additives12
 Developers12
 Lipophilic Emulsifier12
 Hydrophilic Emulsifier13
 Kits13
 Specification Conformance Chart14
 Accessories15-17
 Equipment18-20

MAGNAGLO®/MAGNAFLUX®

Benefits and Applications21
 Wet Method Fluorescent Magnetic Particles22
 Wet Method Visible Magnetic Particles23
 Oil Petroleum Vehicle23
 Dry Method Magnetic Particles24
 Water Bath Additives24
 Magnetizing Yoke and Coil Kits25
 Specification Conformance Chart26
 Accessories27-35
 Equipment36-39

DARACLEAN® CLEANERS

Benefits and Applications40
 Cleaning Process Selection Guide41
 Cleaners42-43
 MagnaVu43
 Specification Conformance Chart44

BLACK LIGHTS

Black Lights and Accessories45-48

SPECIALTY PRODUCTS

SCRUBS™ Hand Cleaner Towels49
 P-1A Partek49
 Ultra Clear Cleaner49
 ZAF-2 – Foaming Agent49
 Foilcheck49

PROCESS SELECTION GUIDE

MAGNETIC PARTICLE INSPECTION vs. LIQUID PENETRANT INSPECTION

	Magnetic Particle	Liquid Penetrant Inspection
Material	Steel only	All metals, ceramics
Will Find	Surface and slightly subsurface cracks	Surface cracks only
Part Cleanliness	Important	Extremely important
Time Factor	Immediate results	10 to 30 minutes
Kit Cost	\$500 to \$1,000	\$50 to \$450
Required Equipment	A magnetizing unit	Red dye – none Fluorescent dye – black light

THE MAGNAFLUX® ADVANTAGE

There are many reasons why you should consider MAGNAFLUX® for your NDT requirements:

- MAGNAFLUX® offers strong brand recognition. We are the industry leader with over 50% of the market share and a reputation of excellent quality and service. We also have an extensive distributor network which makes it more convenient for customers to buy our product. We can back up the demands that our brand power dictates.
- MAGNAFLUX® offers a broad product line which includes:
 - SPOTCHECK Visible Dye Penetrants – in aerosol, kits and bulk
 - ZYGLO Fluorescent Dye Penetrants – in aerosol, kits and bulk
 - MAGNAGLO Fluorescent Magnetic Particles
 - MAGNAFLUX Visible Magnetic Particles
 - DARACLEAN Aqueous Cleaner and MAGNAVU Alkaline Cleaner
 - Portable Magnetic Particle Yokes and Coils
 - Magnetic Particle Equipment – from large automated systems to small portable power packs
 - Penetrant Inspection and Wastewater Disposal Equipment
 - Black Lights and Meters
 - Broad assortment of Operating and Monitoring Accessories
 - PENECCERT Testing
- MAGNAFLUX® offers one-stop shopping. Where many of our competitors handle only one or two product lines.
- MAGNAFLUX® offers environmentally friendly chemicals. We use no “known or suspected” carcinogens in any of our products. We offer water washable and water-based products as alternatives to solvent based. We use higher grade solvents that produce less odor. We offer high grade carrier oil for lower odor and less skin irritation.
- MAGNAFLUX® products are formulated to offer the best product performance. We are selective in the dyes we use and their concentrations. Since dye is a large part of the makeup of our products, the amount of concentration does affect the cost. Most of the products we sell have to meet strict military and industry specifications; therefore, our products are designed to find the smallest possible cracks.
- MAGNAFLUX® Magnetic Particles are designed to hold up better and not break down during agitation. This avoids frequent bath changes.
- MAGNAFLUX® offers excellent customer service and technical support. We have sales people in the field ready to help at a moment's notice, and a technical staff ready to answer your questions on the spot. Our R & D department is constantly working on new products to make your job easier, and give more value to our products and processes.
- MAGNAFLUX® delivers the quality and service you expect and deserve.



GUIDE TO INDUSTRIAL BUYERS AND USERS OF MAGNAFLUX TESTING PRODUCTS

Aerospace Industry

Aircraft Manufacturers
Aircraft Component Manufacturers
Aircraft Overhaul Shops
Airlines

- engine components (blades, rotors & turbines)
- landing gear
- wheels
- wing spars
- brakes
- springs

Amusement Rides

- rotating & moving parts
- rails

Automotive Components Manufacturers

- brakes
- steering components
- connecting rods
- wheels
- engine mounts
- pistons
- cylinder blocks

Automotive Rebuilders

- engine blocks & heads

Fabrication Shops

- welds in tanks

Fire Departments

- ladders

Food Processing Equipment

- mixing tanks
- deep fryers

Foundries

- raw castings

Law Enforcement

- restoring automobile & weapon serial numbers

Lifting Devices

- fork lifts
- crane hooks

Maintenance Shops

- overhead cranes
- crane hooks
- valves
- welds
- drill bits
- boilers

Marine

- hulls
- spars
- engines

Military

- aircraft (and various)

Pipelines

- welds
- valves

Pressure Vessel Manufacturers

- welds

Railroads

- major railway systems
- local transit authorities
 - wheels
 - axles
 - brakes

Shipyards

- welds

Ski Lifts

- gears

Steel Mills

- billets
- tube ends
- bar stock

Storage Tank Companies

- welds
- leak testing

Test Labs

- NDT inspections

Tool Shops

- drills
- saw blades
- bits

Utilities

- nuclear power plants
- electric & gas utilities
 - turbines
 - welds
 - valves
 - pipes

Welding Shops

- welds



SPOTCHECK® PENETRANTS



SPOTCHECK® is a red visible nondestructive test method, which provides for the detection of surface discontinuities (flaws) in ferrous and non-ferrous test materials.

- ▶ *Ideal for applications where portability is required.*
- ▶ *Available in aerosol or liquid form.*
- ▶ *The vivid red color permits daylight inspection.*
- ▶ *Meets major military specifications.*
- ▶ *A complete line of cleaners and developers, as well as Water Wash or Post Emulsifiable penetrants, are available.*

Benefits

SPOTCHECK is the most reliable and widely used penetrant inspection method that reveals cracks and other surface discontinuities in virtually any non-porous material.

SPOTCHECK's formulation, using a high concentration of quality dyes, together with high quality solvents, provides the *best possible dye penetrants* for finding the smallest and finest defects. Other products may skimp on dyes or use inferior solvents that cut costs. In doing so, indications do not appear as bright or vibrant and cracks can be missed. Some inferior solvents may also cause health hazards.

- ▶ Our developer's even spray pattern insures a uniform coating, as where some developer's spray is too harsh, which can impair the function of the developer.
- ▶ Our SPOTCHECK products are the most widely used in the inspection of welds in a variety of industries.
- ▶ Dependability, consistency and safety should be the major concern in your inspection process – MAGNAFLUX® has it all.

Applications

SPOTCHECK delivers accurate, reliable crack detection results in the following applications:

- ▶ Automobile Parts
- ▶ Off-Road Equipment
- ▶ Farm Equipment
- ▶ Welds
- ▶ Castings
- ▶ Forgings
- ▶ Leak Testing
- ▶ Pressure Vessels/Aircraft Maintenance
- ▶ Marine Construction/Maintenance
- ▶ Petroleum Pipelines
- ▶ Power Plant Inspections
- ▶ General Metalwork

How to use



Preclean inspection area. Spray on Cleaner/Remover. Wipe off with cloth.



Apply Penetrant. Allow short penetration period.



Spray Cleaner/Remover on wiping towel and wipe surface clean.



Spray on thin, uniform film of Developer.



Inspect. Defects will show as bright red lines in white developer background.

Penetrants

SKL-SP1

Solvent Removable Penetrant

Most widely used, general purpose solvent removable penetrant. Good for rough surfaces and large parts.
Approved Developers: SKD-S2 & ZP-5B
Approved Cleaner: SKC-S

Part #:	Container Size:
01-5150-68	Case of 12 – 12 oz. Aerosols
01-5150-78	Case of 12 – 16 oz. Aerosols*
01-5150-35	Case of 4 – 1 Gallon Containers
01-5150-40	5 Gallon Pail
01-5150-45	55 Gallon Drum

SKL-WP

Water Washable Penetrant

General purpose water washable penetrant.
Approved Developers: SKD-S2 & ZP-5B
Approved Cleaner: Not Required

Part #:	Container Size:
01-5182-68	Case of 12 – 12 oz. Aerosols
01-5182-78	Case of 12 – 16 oz. Aerosols*
01-5182-35	Case of 4 – 1 Gallon Containers
01-5182-40	5 Gallon Pail
01-5182-45	55 Gallon Drum

SKL-4C

Water Based Penetrant

Bright red in the daylight; fluorescent orange in UV light. Liquid oxygen compatible. For non-certified applications. Used as a leak detector and for inspection of plastic.
Approved Developer: SKD-S2
Approved Cleaner: Not Required

Part #:	Container Size:
01-5125-40	5 Gallon Pail
01-5125-45	55 Gallon Drum



Cleaners/Removers

SKC-S

Solvent Cleaner

The recommended, general purpose cleaner/remover. Non-Chlorinated. Flammable. Meets major requirements for major specifications.

Part #:	Container Size:
01-5750-68	Case of 12 – 12 oz. Aerosols
01-5750-78	Case of 12 – 16 oz. Aerosols*
01-5750-35	Case of 4 – 1 Gallon Containers
01-5750-40	5 Gallon Pail
01-5750-45	55 Gallon Drum

SKC-HF

Solvent Cleaner

High Flash point. Low odor cleaner/remover. Meets sulfur and chlorine requirements of major specifications.

Part #:	Container Size:
01-5725-68	Case of 12 – 12 oz. Aerosols
01-5725-35	Case of 4 – 1 Gallon Containers
01-5725-40	5 Gallon Pail
01-5725-45	55 Gallon Drum

Developers

SKD-S2

Solvent Developer

General purpose solvent developer.

Part #:	Container Size:
01-5352-68	Case of 12 – 12 oz. Aerosols
01-5352-78	Case of 12 – 16 oz. Aerosols*
01-5352-35	Case of 4 – 1 Gallon Containers
01-5352-40	5 Gallon Pail
01-5352-45	55 Gallon Drum

ZP-5B

Aqueous Water Suspensible Developer

General purpose water suspensible developer.

Part #:	Container Size:
01-3341-81	25 lb. Container

SPOTCHECK® Kits



- ▶ SPOTCHECK visible penetrant kits quickly locate surface cracks.
- ▶ Easy to transport for field inspections.
- ▶ No UV light required because of vivid red color.
- ▶ Includes SKL-SP1 penetrant, SKC-S cleaner and SKD-S2 Developer.

SK-412 Portable Kit (12 Oz.)

Part #:
01-5960-48

Includes:
1 can of SKL-SP1, 2 cans of SKC-S, 1 can of SKD-S2, Heavy Duty Wiping Cloth, Paint Marker, Scrubs Hand Towels, Portable Plastic Case and Instructions.

01-5970-48 SK-416 (16 oz.cans)*



SK-S General Purpose Kit (12 Oz.)

Part #:
01-5912-48

Includes:
2 cans of SKL-SP1, 2 cans of SKD-S2 and 4 cans of SKC-S. Plus Plastic Carrying Case, Wiping Cloths, Wire Brush and Instructions.

SPOTCHECK® Specification Conformance Chart

Specification	Penetrants			Cleaners		Developers	
	SKL-SP1	SKL-WP	SKL-4C	SKC-S	SKC-HF	SKD-S2	ZP-5B
NAVSEA T9074-AS-GIB-010/271	x	x		x	x	x	x
MIL-STD-2132	x	x		x	x	x	x
AECL	x	x		x	x	x	x
AMS-2644	x	x	x	x	x	x	x
ASME B & PV Code, Sec. V	x	x	x	x	x	x	x
ASTM E 165	x	x	x	x	x	x	x
ASTM E-1417	x	x	x	x	x	x	x
Boeing BAC 5423 PSD 6-46 or 8-4	x	x		x		x	x
General Electric P50YP107	x	x		x	x	x	x
Boeing PS-21202	x			x	x	x	x
NAVSEA 250-1500-1	x			x	x	x	

*16 oz. cans international only

ZYGLO® PENETRANTS

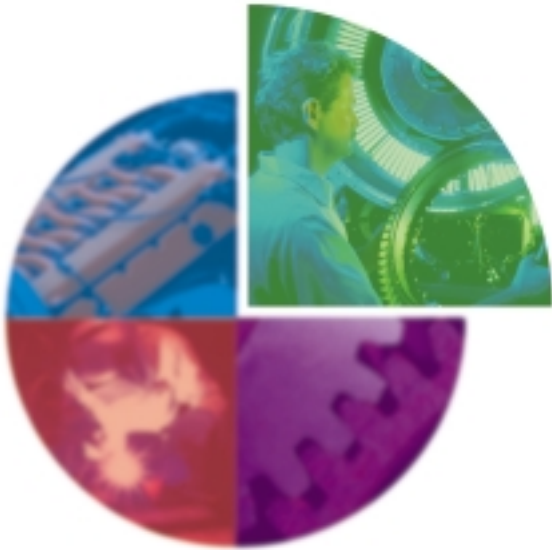

ZYGLO® is an extremely sensitive fluorescent penetrant inspection method that reveals cracks and other surface discontinuities in virtually any non-porous material.

- ▶ ZYGLO is available in aerosols and liquid form.
- ▶ Five sensitivity levels to satisfy military, industry or company specifications.
- ▶ Water Wash and Post Emulsifiable penetrants are available.
- ▶ Full line of emulsifiers, removers and developers.

Benefits

ZYGLO fluorescent penetrants are formulated to offer improved sensitivity, brightness and resistance to over washing. Just like our visible penetrants we use high quality raw materials to give superior results in finding defects. Our ZYGLO penetrant products are known in the industry for their consistent performance and reliability. They are preferred by many of the largest aircraft manufacturers and overhaul facilities.

MAGNAFLUX manufactures penetrant materials, accessories and equipment, making us a one-stop shop. We are involved in the total process from start to finish, and produce our products to perform to the utmost of effectiveness when used together.

Applications

- ▶ **Aerospace Industry**
(Aircraft Manufacturers, Aircraft Component Manufacturers, Aircraft Overhaul Shops, Airlines)
Engine components (blades, rotors & turbines)
Landing gear
Wheels
Wing spars
Brakes
Springs
- ▶ **Automotive Components Manufacturers**
Brakes
Steering components
Connecting rods
Wheels
Engine mounts
Pistons
Cylinder blocks
- ▶ **Foundries**
Raw Castings
- ▶ **Test Labs**
NDT Inspections

How to use



Pre-clean inspection area. Spray on Cleaner/Remover. Wipe off with cloth.



Apply Penetrant. Allow short penetration period.



Spray Cleaner/Remover on wiping cloth and wipe surface clean.



Apply a thin film of developer. Allow short developing period. For rough surfaces, daub on Dry Developer.

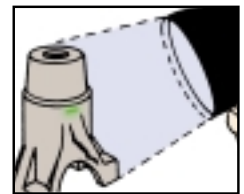

Inspect under black light. Cracks and lack of bond will show as glowing lines, porosity will show as spots.

Liquid Penetrant Classification Per AMS 2644

Penetrant Types:

- ▶ Type 1 – fluorescent dye
- ▶ Type 2 – visible dye

Penetrant Sensitivity

Levels:

Sensitivity level (fluorescent only)

- ▶ ½ – ultra low
- ▶ 1 – low
- ▶ 2 – medium
- ▶ 3 – high
- ▶ 4 – ultra high

Penetrant Methods:

- ▶ Method A – water washable
- ▶ Method B – post emulsifiable, lipophilic
- ▶ Method C – solvent removable
- ▶ Method D – post emulsifiable, hydrophilic

Developer Forms:

- ▶ Form a – dry powder
- ▶ Form b – water soluble
- ▶ Form c – water suspendible
- ▶ Form d – nonaqueous Type 1 fluorescent (solvent based)
- ▶ Form e – nonaqueous Type 2 visible dye (solvent based)

Penetrant Inspection Method

Types of FLAWS likely to be encountered and their causes

- ▶ **Most will be service-caused cracks**
 - *Overstress – caused by stressing part beyond its elastic limit*
 - *Fatigue cracks – caused by repeated stress and relaxation of part.*
 - *Corrosion cracks – caused by exposure to corrosive media or atmosphere.*
- ▶ **Repair operations can also cause cracks**
 - *Welding*
 - *Grinding*
 - *Machining*
 - *Heat Shrinkage*
 - *Leaks*
- ▶ **Penetrant Method is usable:**
 - *Where cracks are open to the surface.*
 - *On any material which is NOT excessively porous.*
 - *On any material which will not be harmed by chemicals or procedures.*
- ▶ **Part preparation and Cleaning**
 - *For penetrant method to work, defect must be clean and open to the surface.*
- ▶ **Cracks must be empty and dry for penetrant to enter.**
 - *Ultrasonic cleaning is usually best method.*
 - *Alkaline cleaning may be applicable.*
 - *Steam cleaning may or may not work, depending on soil.*
 - *Parts must be dry before penetrant processing*
- ▶ **Choice of Penetrant Method Depends On:**
 - *Sensitivity required*
 - *Number of parts to be tested*
 - *Surface condition of part being inspected*
 - *Configuration of test specimen*
 - *Availability of water, electricity, compressed air, suitable testing area, etc.*

Which method and sensitivity is best for my application?

Since there are choices for developers, which one should I use?

Since each application is slightly different, we recommend you contact Magnaflux to help guide you through this selection process.

Materials used in Penetrant Testing Systems

- ▶ **Water-Washable Penetrants** contain emulsifiers, which makes them easily removable by a water rinse or wash.
 - *The most economical removal method*
 - *Fewer processing steps*
 - *Highly procedure dependent since over-washing can occur*
 - *Not good for wide or shallow flaws*
 - *Effluent disposal may be a problem*
- ▶ **Post Emulsifiable Penetrants** are highly penetrating, oily fluorescent penetrants that are not soluble in water. These penetrants must be treated with an emulsifier before they can be removed by a water rinse or wash.
 - *Two methods of PE removal, hydrophilic (the most commonly used) and lipophilic*
 - *Highly sensitive to very fine cracks*
 - *The ability to show wide, shallow cracks*
 - *Better control of removal process*

Developers:

- ▶ **Dry developers**
 - *Are fluffy dry powders, used as received*
 - *Are not usable with visible penetrants*
 - *Parts must be completely dried before application of developer*
 - *May be applied by spray, manual duster, dipping*
 - *Will produce small indications with little or no background*
 - *Dust masks may be required*
- ▶ **Aqueous developers**
 - *Are supplied as dry powders to be mixed with specified amounts of water. These powders are either soluble or suspended.*
 - *Suspended developers need to be agitated*
 - *Parts do not need to be dried before application*
- ▶ **Nonaqueous (solvent based) developers**
 - *Are supplied premixed and ready to use*
 - *Applied only by spray*
 - *Are the most sensitive developers because solvent redissolves and spreads penetrant*
 - *Are the most expensive developer type because of high material cost and labor intensive application.*

METHOD A WATER-WASHABLE

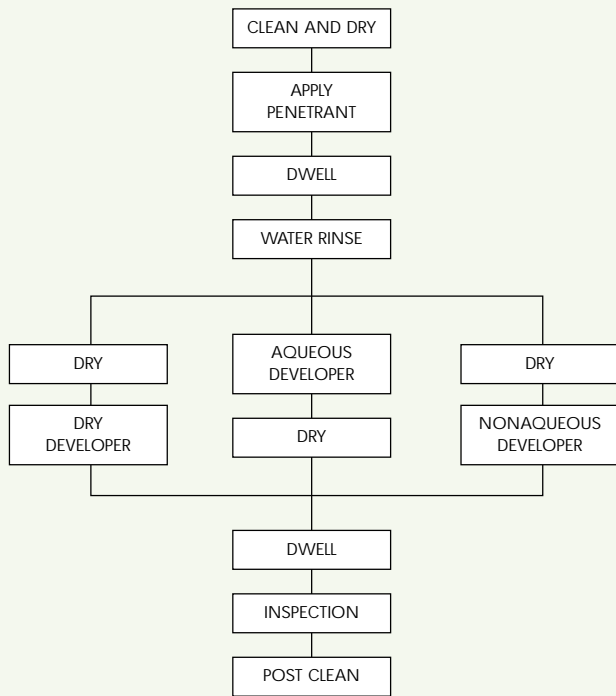

METHOD B LIPOPHILIC

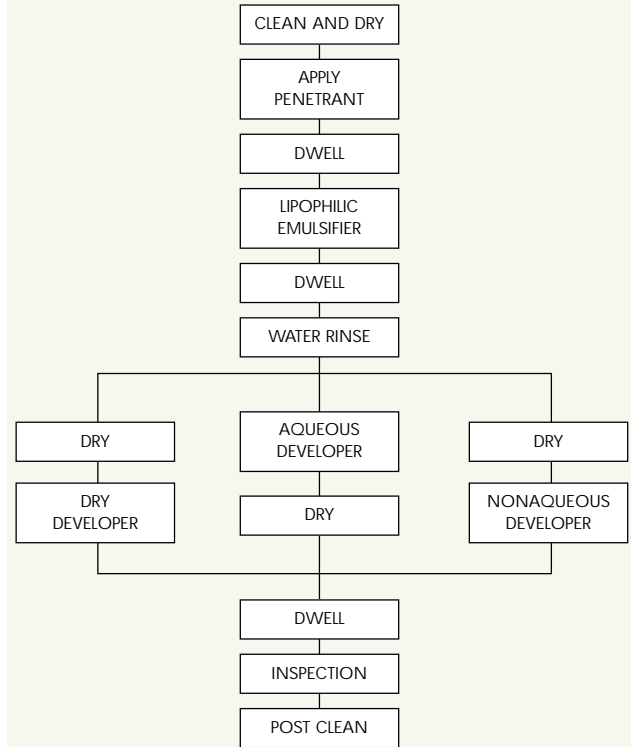

METHOD C SOLVENT REMOVABLE

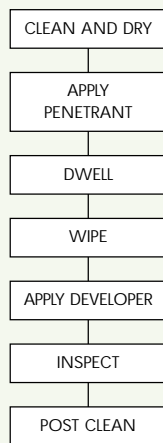

METHOD D HYDROPHILIC

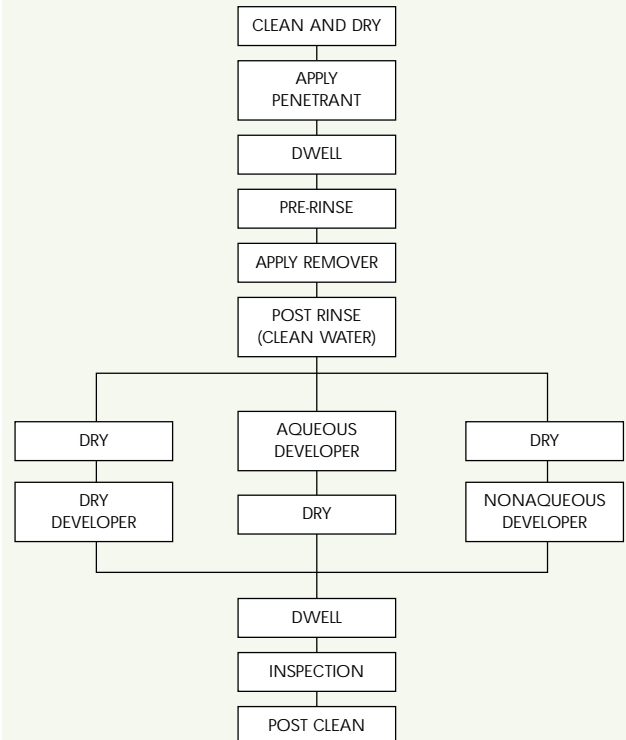

ZYGLO Water Washable Penetrants

ZYGLO Water Washable Penetrants are used to check for cracks in a wide range of sensitive applications. Our penetrants fluoresce a greenish-yellow color under ultraviolet radiation. Use black light sources with peak wavelength of 365 nanometers such as MAGNAFLUX ZB-100F Fan-Cooled Black Light.

ZL-15B Water Washable Fluorescent Penetrant

(Level ½ – Lowest sensitivity)
Exhibits excellent washability for castings and rough surfaces.
Approved Developers: ZP-4B, ZP-9F, ZP-5B & SKD-S2

Part #:	Container Size:
01-3159-40	5 Gallon Pail
01-3159-30	20 Gallon Drum
01-3159-45	55 Gallon Drum

ZL-19 Water Washable Fluorescent Penetrant

(Level 1 – Low sensitivity penetrant)
Higher brightness and sensitivity than ZL-15B
Approved Developers: ZP-4B, ZP-9F, ZP-5B & SKD-S2

Part #:	Container Size:
01-3263-40	5 Gallon Pail
01-3263-30	20 Gallon Drum
01-3263-45	55 Gallon Drum

ZL-60D Water Washable Fluorescent Penetrant

(Level 2 – Medium Sensitivity)
Exhibits excellent washability for castings and rough surfaces; and is typically used on castings, forgings, extrusions and rough machined surfaces to find cracks, seams, laps, cold shuts, laminations and porosity.
Approved Developers: ZP-4B, ZP-9F, ZP-5B & SKD-S2

Part #:	Container Size:
01-3272-68	Case of 12 – 12 oz. Aerosols
01-3272-78	Case of 12 – 16 oz. Aerosols*
01-3272-35	Case of 4 – 1 Gallon Containers
01-3272-40	5 Gallon Pail
01-3272-30	20 Gallon Drum
01-3272-45	55 Gallon Drum

ZL-67 Water Washable Fluorescent Penetrant

(Level 3 – High Sensitivity)
Provides an excellent combination of sensitivity/washability and is typically used on critical applications including investment castings, jet engine components, and highly machined surfaces to find cracks, seams and porosity.
Approved Developers: ZP-4B, ZP-9F, ZP-5B & SKD-S2

Part #:	Container Size:
01-3274-35	Case of 4 - 1 Gallon Containers
01-3274-40	5 Gallon Pail
01-3274-30	20 Gallon Drum
01-3274-45	55 Gallon Drum

ZL-56 Water Washable Fluorescent Penetrant

(Level 4 – Ultra High Sensitivity)
Ultra-high sensitivity penetrant for critical applications. ZL-56 is a fluorescent, high sensitivity, water washable penetrant. ZL-56 is typically used on smooth, nonporous, highly machined surfaces to find cracks, seams, and scratches.
Approved Developers: ZP-4B, ZP-9F, ZP-5B & SKD-S2

Part #:	Container Size:
01-3267-40	5 Gallon Pail
01-3267-30	20 Gallon Drum
01-3267-45	55 Gallon Drum



*16 oz. cans international only

ZYGLO® Post Emulsifiable Fluorescent Penetrants

The ZYGLO post emulsifiable fluorescent penetrants are used for a wide range of sensitive applications and are formulated to be impervious to water to assure against being over washed from defects. The MAGNAFLUX Post Emulsifiable Penetrants require the application of a lipophilic emulsifier or a hydrophilic emulsifier to render it washable with water. All of our penetrants are formulated for rapid separation from water for efficient clean up by coalescer, or charcoal filtration. Each penetrant fluoresces a bright greenish-yellow color under ultraviolet radiation. Use of a black light source, with peak wavelength of 365 nanometers, such as the MAGNAFLUX® ZB-100F Fan-Cooled black light, is recommended. Each penetrant is formulated to produce heat stable fluorescent indications under normal drying conditions (140°F/60° C).

ZL-2C PE Fluorescent Penetrant

(Level 2 – Medium Sensitivity)

ZL-2C is typically used on castings, forgings, and extrusions, rough and machined surfaces to find cracks, seams, laps, laminations and porosity.

Approved Developers: ZP-4B, ZP-9F, ZP-5B, ZP-14A & SKD-S2

Approved Removers: ZR-10B, ZE-4B, SKC-S & SKC-HF

Part #:	Container Size:
01-3123-40	5 Gallon Pail
01-3123-30	20 Gallon Drum
01-3123-45	55 Gallon Drum

ZL-27A PE Fluorescent Penetrant

(Level 3 – High Sensitivity)

ZL-27A is typically used on castings, forgings, and extrusions, rough and machined surfaces to find cracks, seams, laps, laminations and porosity.

Approved Developers: ZP-4B, ZP-9F, ZP-5B, ZP-14A & SKD-S2

Approved Removers: ZR-10B, ZE-4B, SKC-S & SKC-HF

Part #:	Container Size:
01-3187-68	Case of 12 – 12 oz. Aerosols
01-3187-78	Case of 12 – 16 oz. Aerosols*
01-3187-35	Case of 4 – 1 Gallon Containers
01-3187-40	5 Gallon Pail
01-3187-30	20 Gallon Drum
01-3187-45	55 Gallon Drum

ZL-37 PE Fluorescent Penetrant

(Level 4 – Ultra-High Sensitivity)

ZL-37 is typically used on castings, forgings, and extrusions, rough and machined surfaces to find cracks, seams, laps, laminations and porosity.

Approved Developers: ZP-4B, ZP-9F, ZP-5B, ZP-14A & SKD-S2

Approved Removers: ZR-10B, ZE-4B, SKC-S & SKC-HF

Part #:	Container Size:
01-3188-35	Case of 4 – 1 Gallon Containers
01-3188-40	5 Gallon Pail
01-3188-30	20 Gallon Drum
01-3188-45	55 Gallon Drum



Penetrant Pen Fluorescent Penetrant Pen for Rework

(Level 4 – Ultra High Sensitivity Penetrant)

Penetrant Pen contains ZL-37 penetrant in an industrial marker pen for reworking parts.

Approved Developers: ZP-4B, ZP-9F, ZP-5B, ZP-14A & SKD-S2

Approved Remover: ZR-10B, ZE-4B, SKC-S & SKC-HF

Part #:	Container Size:
01-3188-75	12 Pens/Box

ZYGLO® Water Base Fluorescent Penetrant

ZL-4C Water Base Fluorescent Penetrant

ZL-4C is a fluorescent, water base penetrant. ZL-4C is soluble in water and can be diluted, but is generally used as supplied or from 1:1 to 1:2 in water. ZL-4C contains no petroleum base solvents. ZL-4C fluoresces a greenish-yellow color under ultraviolet radiation of 365 nm, such as supplied by the MAGNAFLUX® ZB-100F fan-cooled black light.

Part #:	Container Size:
01-3137-40	5 Gallon Pail
01-3137-45	55 Gallon Drum

*16 oz. cans international only

ZYGLO® Additive

ZL-5 Fluorescent Water Additive for Leak Detection

ZL-5 is a dry powder fluorescent organic material used as an additive for the detection of leaks in pressure vessels, storage tanks, radiators and other liquid system containers. ZL-5 is water-soluble and produces fluorescence when using a black light, (such as the MAGNAFLUX® ZB-100F fan cooled black light) at 365 nanometers.

Part #:	Container Size:
01-3141-57	1 lb. Container
01-3141-63	5 lb. Container

ZYGLO® Developers

ZP-4B Dry Powder

ZP-4B is a free-flowing, white, fluffy powder used as a dry powder developer for ZYGLO penetrants. ZP-4B is supplied ready to use. ZP-4B forms a thin film on parts which enables it to enhance indications of ultra fine discontinuities. ZP-4B's high purity allows it to be used in applications demanding purity.

Part #:	Container Size:
01-3328-25	12 – 1 pt Cans
01-3328-69	10 lb. Container
01-3328-75	20 lb. Container

ZP-5B Water Suspending

ZP-5B is a white powder which is to be dispersed into water. ZP-5B disperses quickly to form an opaque white suspension. Must be continually agitated during use to ensure uniformity of mix as developer will settle out on standing. ZP-5B forms a uniform white coating which enhances fluorescent indications formed by ZYGLO penetrants. At higher concentration, ZP-5B forms an opaque white coating which provides contrasting background for SPOTCHECK indications.

Part #:	Container Size:
01-3341-81	25 lb. Container

ZP-9F Non-Aqueous

ZP-9F is a ready-to-use suspension of white developing particles in a fast drying solvent. ZP-9F produces an opaque white coating, which provides an excellent contrasting background for SPOTCHECK or ZYGLO penetrant indications. ZP-9F is specially formulated to be low in sulfur and halogens and contains no chlorinated hydrocarbons.

Part #:	Container Size:
01-3354-68	Case of 12 - 12 oz. Aerosols
01-3354-78	Case of 12 - 16 oz. Aerosols*
01-3354-40	5 Gallon Pail

ZP-14A Water Soluble

ZP-14A is a white free-flowing powder, which dissolves in water to form a clear, colorless biodegradable developer solution. ZP-14A is used as a general purpose water-soluble developer for the enhancement of indications formed by ZYGLO penetrants. ZP-14A produces a uniform white porous coating when it dries. The developer film is easily removed in post inspection cleaning by a water spray. Once the developer bath has been made up, no in-use agitation is required to maintain developer uniformity.

Part #:	Container Size:
01-3381-75	20 lb. Container
01-3381-89	50 lb. Container

ZYGLO® Lipophilic Emulsifier

ZE-4B Emulsifier

ZE-4B is a reddish, slightly viscous liquid used for the emulsification of ZYGLO PE penetrants. ZE-4B is a general purpose emulsifier with a moderate rate of action. ZE-4B can be used in open tanks due to its low volatility and high flash point.

Part #:	Container Size:
01-3546-40	5 Gallon Pail
01-3546-30	20 Gallon Drum
01-3546-45	55 Gallon Drum

*16 oz. cans international only

ZYGLO® Hydrophilic Emulsifier

ZR-10B Remover

ZR-10B is a pinkish, slightly viscous liquid. ZR-10B is a 100% active concentrate, which is diluted in water when used as an emulsifier for ZYGLO PE penetrants. ZR-10B is very low in sulfur, chlorine, and sodium content.

Part #:	Container Size:
01-3620-40	5 Gallon Pail
01-3620-30	20 Gallon Drum
01-3620-45	55 Gallon Drum

ZYGLO® Kits



NEW ZA-70 Kit (12 Oz.) 115v ZB-100F Black Light

Part #	Includes
600044	ZB-100F Black Light (Note Voltage on Order) 1 can of ZL-27A PE Fluorescent Penetrant, 1 can of ZP-9F Developer, 2 cans of SKC-S Cleaner, heavy duty wiping cloth, paint marker, Scrubs™ hand towels, portable plastic case and instructions
600047	ZB-100F 115v 16 oz. cans*
600045	ZB-100F 230v 16 oz. cans*

ZA-60R Refill Kit

Part #	Includes
01-3926-48	2 cans of ZL-27A PE Fluorescent Penetrant, 2 cans ZP-9F Developer, 1 pint of ZP-4B Dry Powder Developer, 3 cans of SKC-S Cleaner, Plastic case, can gun, wire brush and instructions

*16 oz. cans international only

ZYGLO® Specification Conformance Chart

Specification	Water Washable Penetrants					Post Emulsifiable Penetrants		
	ZL-15B	ZL-19	ZL-60D	ZL-67	ZL-56	ZL-2C	ZL-27A	ZL-37
NAVSEA T9074-AS-GIB-010/271	x	x	x	x	x	x	x	x
MIL-STD-2132	x	x	x	x	x	x	x	x
AECL	x	x	x	x	x	x	x	x
AMS-2644	x	x	x	x	x	x	x	x
AMS-2647			x	x	x	x	x	x
ASME B & PV Code, Sec. V	x	x	x	x	x	x	x	x
ASTM E 165	x	x	x	x	x	x	x	x
ASTM E-1417	x	x	x	x	x	x	x	x
Boeing BAC 5423 PSD 6-46 or 8-4	x	x	x	x	x	x	x	x
Garrett EMS 52309	x	x	x	x	x	x	x	x
General Electric P3TF2			x	x	x	x	x	x
General Electric P5OYP107	x	x	x	x	x	x	x	x
Boeing PS-21202	x	x	x	x	x	x	x	x
Pratt & Whitney FPM		x	x	x		x	x	x

Specification	Emulsifiers & Removers				Developers			
	ZE-4B	ZR-10B	SKC-S	SKC-HF	ZP-4B	ZP-14A	ZP-5B	ZP-9F
NAVSEA T9074-AS-GIB-010/271	x	x	x	x	x	x	x	x
MIL-STD-2132	x	x	x	x	x	x	x	x
AECL	x	x	x	x	x	x	x	x
AMS-2644	x	x	x	x	x	x	x	x
AMS-2647	x	x	x	x	x	x	x	x
ASME B & PV Code, Sec. V	x	x	x	x	x	x	x	x
ASTM E 165	x	x	x	x	x	x	x	x
ASTM E-1417	x	x	x	x	x	x	x	x
Boeing BAC 5423 PSD 6-46 or 8-4	x	x	x	x	x	x	x	x
Garrett EMS 52309	x	x	x	x	x	x	x	x
General Electric P3TF2	x	x	x	x	x	x	x	x
General Electric P5OYP107	x	x	x		x		x	
Boeing PS-21202	x	x	x	x	x	x	x	x
Pratt & Whitney FPM		x			x			x

ZYGLO® ACCESSORIES

Hand Sprayers



Water Spray Gun

- ▶ For rinsing either water-wash or post-emulsifiable penetrants
- ▶ Coarse spray

Part #: 520090



Dry Developer Spray Gun

- ▶ Provides light, even developer coating
- ▶ Uses shop compressed air (dry)
- ▶ Features mix, jet and spread controls
- ▶ Two quart capacity

Part #: 521339



Hydro-Wash Spray Gun

- ▶ For water rinsing of parts
- ▶ Air injection boosts velocity, permits faster rinsing with less water usage
- ▶ Useful with low or fluctuating water pressure
- ▶ For spray distances over three feet or when rinsing hollow or rough surface parts

Part #: 518992



Portable Pressure Sprayer

- ▶ Lightweight pressure sprayer for spot application of penetrants, developers and cleaners
- ▶ Includes interchangeable nozzles for mist or pin spray
- ▶ Chrome-plated solid brass construction, one-quart capacity
- ▶ Pressurized with compressed air or with CO₂ cartridges to a maximum of 200 psi

Part #: 195260

NOTE: Ensure compatibility with governing specification that inspection work must meet before using this technique.

Water Pressure Gauge and Regulator



Water Pressure Gauge

- ▶ For use with water regulators

Part #: 513759



½ I.P.S. Water Pressure Regulator

- ▶ ¾" I.P.S. (#513757) and 1" I.P.S. (#513758) also available outlet ports
- ▶ Adjustable from 2 psig to 125 psig

Part #: 513756

Regulators and gauges for applications requiring strict water pressure control.

Hydrophilic Emulsifier Injector Kit

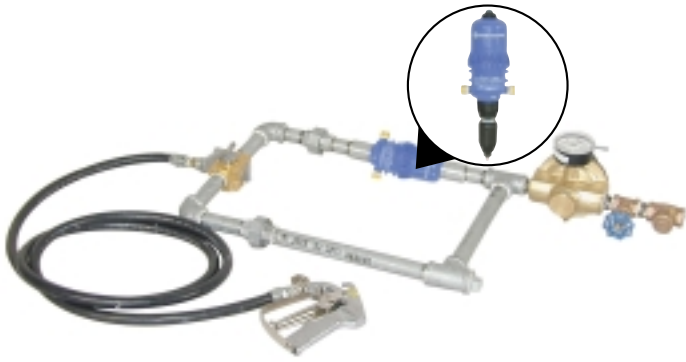

Hydrophilic Emulsifier Injector Kit

Automatically mix ZR-10B hydrophilic emulsifier (remover) with spray rinse water to combine emulsification and rinsing, leaving only a brief final wash. Three-way valve permits selection of water only or water plus remover spray.

- ▶ Dosatron Model Metering Injector
- ▶ For close range rinsing at spray distance up to 4'
- ▶ Externally adjusted
- ▶ Extremely accurate injection rates of 1-5%
- ▶ Flow rates up to 11 GPM

Part #: 609032

Test Blocks

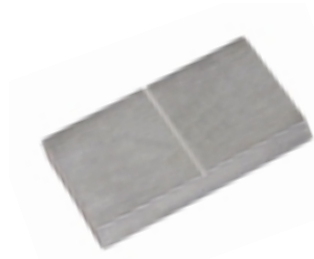

Aluminum Test Block (for sensitivity)

- ▶ Cracked aluminum block compares sensitivity of different penetrants or sensitivity of new and old penetrants
- ▶ Complies with ASTM E165; ASME Boiler and Pressure Vessel code

Part #: 14755



Stainless Steel Test Block (for washability)

- ▶ Monitors washability of water-wash or post-emulsified penetrants
- ▶ Grit-blasted rough surface retains "background" when washability is impaired
- ▶ May be used repeatedly if thoroughly cleaned after each use
- ▶ Complies with ASTM E165

Part #: 154400

Comparators



Crack Comparator

- ▶ General purpose crack comparator, 0.005" to 0.125" increments

Part #: 514048

Metric Crack Comparator

Part #: 514049

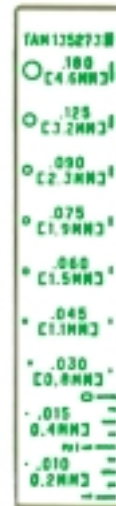

TAM Crack Comparator

- ▶ 0.010" to 0.180" increments
- ▶ Meets Pratt & Whitney requirements (P&W reference: TAM 135273)

Part #: 514050

Test Panels



NiCr Panels

The NiCr penetrant test panels are ideal penetrant sensitivity comparators. The panels are available with crack width of 10, 20, 30, and 50 microns and come in matched pairs. Individual crack sizes or a complete kit of all four sizes are available.

Having matched pairs enables studies of the effects of process changes as compared to a standard process, or used material changes vs fresh material. The panels are ideal for monitoring fluorescent penetrant (ZYGLO) lines.

Part #:	Description:
506251	One Pair of NiCr 10 micron panels
506252	One Pair of NiCr 20 micron panels
506253	One Pair of NiCr 30 micron panels
506254	One Pair of NiCr 50 micron panels
184400	NiCr Panel Set contains one pair of 10, 20, 30, and 50 micron crack size



TAM Panel

- ▶ 4" x 6" stainless steel panel monitors both sensitivity and washability of penetrant process
- ▶ Includes a rough surface for washability testing, plus a polished chrome section with 5 "star" shaped defects ranging in size from coarse to extremely fine
- ▶ Pratt and Whitney TAM #146040

Part #: 198055

Process Control Accessories



Hydrometer

- ▶ Uses specific gravity readings to monitor water based developer concentration and maintain optimum developer performance

Part #: 5857



Refractometer

- ▶ Optical device used for measuring concentration of hydrophilic removers in water
- ▶ Includes chart to convert to percent concentration for ZR-10B ZYGLO hydrophilic removers

Part #: 513829

Purified Penetrant Wiping Cloths

- ▶ For use when specifications require certified pure wiping cloths
- ▶ Includes dispensing rack and manufacturer's certification
- ▶ Case of 12 rolls

Part #: 512302

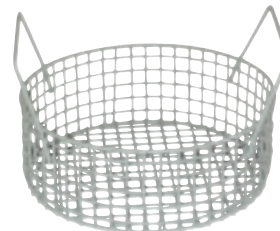

Round Wire Basket

- ▶ 12" diameter nylon-coated processing basket
- ▶ Can be subdivided to prevent part-to-part contact
- ▶ Fits turntable of units with automatic rotary wash

Part #: 1962

Black Lights and Black Light meters (see pages 45–48)

ZYGLO® EQUIPMENT

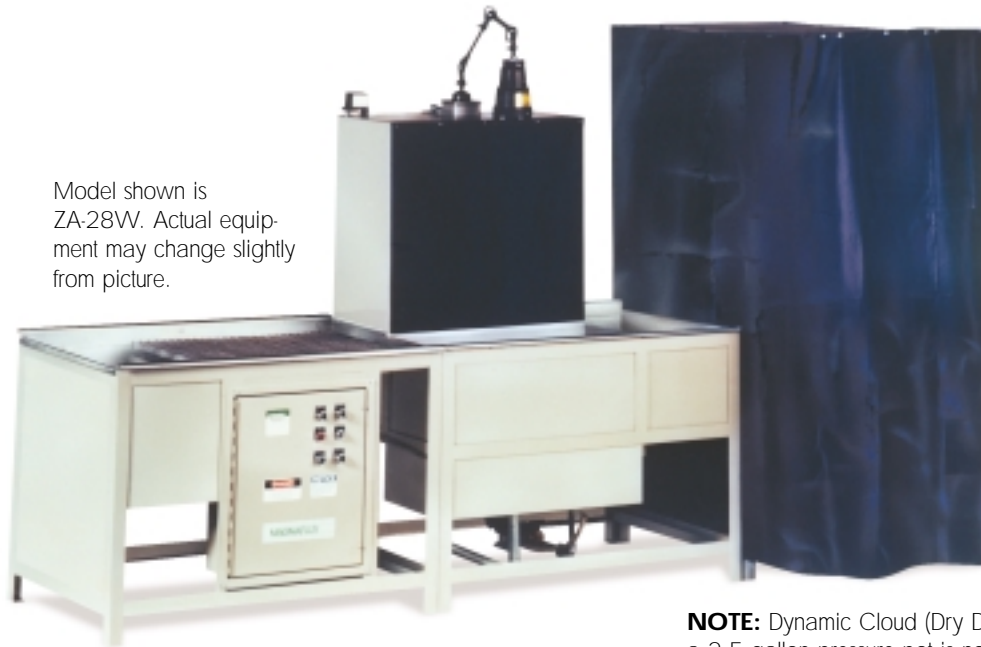

Model shown is ZA-28W. Actual equipment may change slightly from picture.

ZA-28 Penetrant Processing Inspection Equipment

Each of the three ZA-28 models are designed for a specific testing method. Because the order of use varies with different penetrant materials, the units must be carefully ordered to fit the specific application.

NOTE: Dynamic Cloud (Dry Developer) design with dust collection and a 2.5 gallon pressure pot is now available.

ZA-28W Water Washable Penetrant System

Number of Stations: Six (Penetrant Station, Drain Station, Wash Station, Dryer Station, Developer Station, Inspection Station)

Part #:	Description:
34950	ZA-28-W-230V/460V-60 hz.-1 ph
34950-01	ZA-28-W-230V/460V-50 hz.-1 ph

ZA-28H Hydrophilic Penetrant System

Number of Stations: Nine (Penetrant Station, Drain Station, Pre-Rinse Station, Drain Station, Remover Station, Rinse Station, Dryer Station, Developer Station, Inspection Station)
For any other voltage, please call MAGNAFLUX.

Part #:	Description:
168690	ZA-28H-230/460V-60 hz.-1 ph
168690-01	ZA28H-230/460V-50 hz.-1 ph

ZA-28E Post Emulsified Penetrant System

Number of Stations: Eight (Penetrant Station, Drain Station, Emulsifier Station, Rinse Station, Drain Station, Dryer Station, Developer Station, Inspection Station) For any other voltage, please call MAGNAFLUX.

Part #:	Description:
156780	ZA-28H-230/460V-60 hz.-1 ph
156780-01	ZA28H-230/460V-50 hz.-1 ph

Optional Features for ZA-28 Penetrant System

Part #:	Description:
609100	Motorized Turntable
609178-P	Lid, Tank
608363	ZA-28 Inspection Booth

Model shown is ZA-37CW. Actual equipment may change slightly from picture.

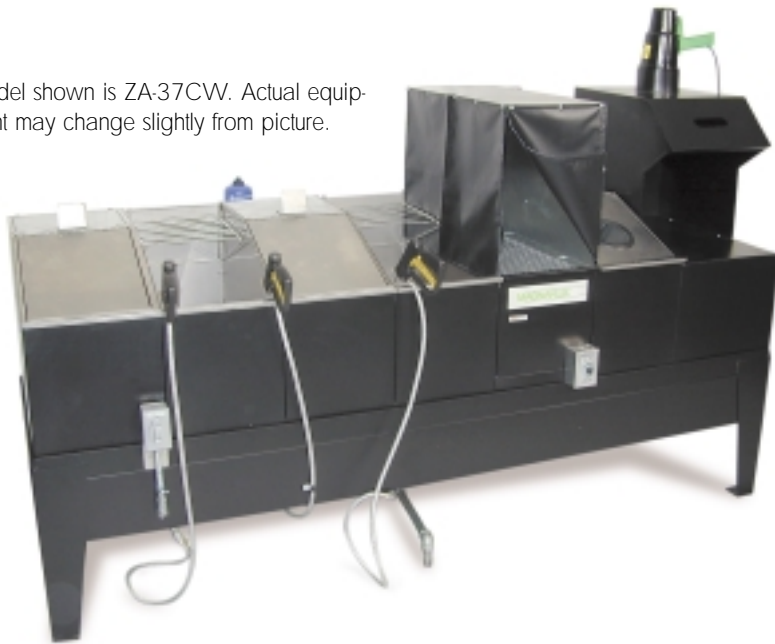

ZA-37 Compact Penetrant Processing Inspection Equipment

Each of the ZA-37 models are designed for a specific testing method. The order of use varies with different penetrant materials, so the units must be carefully ordered to fit the specific application.

NEW!

ZA-37 CW

Cleaning Station Included

Standard Features Include:

- ▶ **Cleaning Station** with pump agitation and heater.
- ▶ **Dynamic Cloud Developer Chamber** with a two gallon pressure pot and foot switch for the dispensing of our ZP-4B Dry Powder Developer, 5" diameter viewing window in cover. Built in dust collector with air filter.
- ▶ **Inspection Booth** with ZB-100F portable black light mounted on top center of booth for fixed inspection or hand held inspection.

The ZA-37 CW is our NEW cost effective, integrated manual system for processing small to medium parts and has:

- ▶ Welded Steel Frame,
- ▶ 304 Stainless Steel Tanks,
- ▶ 120 Volts/60Hz/1 Phase,
- ▶ Overall Length 97"

ZA-37 CW has Seven Stations:

Cleaning Station with pump agitation and heater, Pre-Rinse Tank with Dwell Tray, Penetrant Dip Tank, Final Rinse Station with Dwell Tray, Dryer with 1500 watt heater — thermostat control, Dynamic Cloud Chamber, Inspection Booth (with portable ZB-100F)

Dimensions of first six stations:

12½" Wide x 27" Long x 17" Deep

Dimensions of Inspection Booth:

16¾" Wide x 27" Long x 14" High Viewing Area

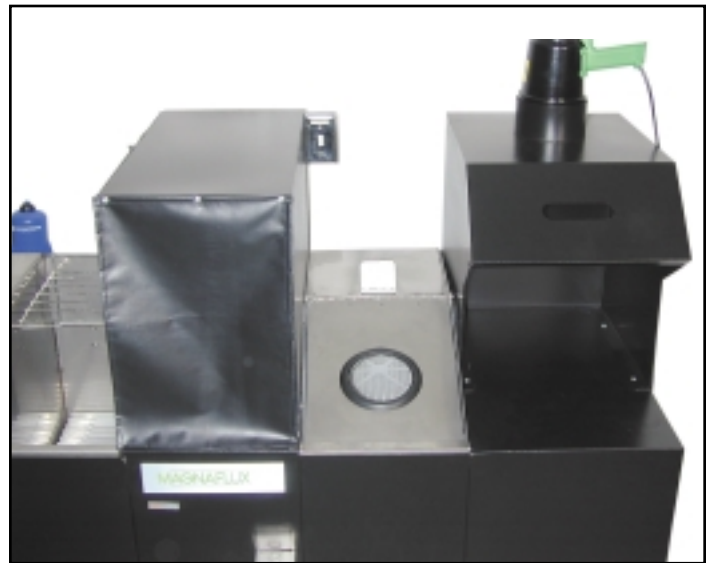

Dryer Station, Dynamic Cloud Developer Station, Inspection Station, shown above.

ZA-37W

Water Washable Penetrant System

Number of Stations: Five (Penetrant Station, Rinse Station, Developer Station, Dryer Station, Inspection Station)

Part #:	Description:
606320	ZA-37W-Water Wash-115V-50/60 Hz-1 ph
606320-1	ZA-37W-Water Wash-230 V-50/60 Hz-1 ph
606320-02	ZA-37W-Water Wash-460V-50/60 Hz-1 ph

ZA-37E

Post Emulsified Penetrant System

Number of Stations: Six (Penetrant Station, Emulsifier Station, Rinse Station, Developer Station, Dryer Station, Inspection Station)

Part #:	Description:
606321	ZA-37E-Post-Emulsified-115V-50/60 Hz-1 ph
606321-01	ZA-37E-Post-Emulsified-230V-50/60 Hz-1 ph
606321-02	ZA-37E-Post-Emulsified-460V-50/60 Hz-1 ph

ZA-37H

Hydrophilic Penetrant System

Number of Stations: Seven (Penetrant Station, Pre-Rinse Station, Remover Station, Final Rinse Station, Developer Station, Dryer Station, Inspection Station)

For any other voltage - please call MAGNAFLUX

Part #:	Description:
606322	ZA-37H-Hydrophilic-115V-50/60 Hz-1 ph
606322-01	ZA-37H-Hydrophilic-230V-50/60 Hz-1 ph
606322-02	ZA-37H-Hydrophilic-460V-50/60 Hz-1 ph

Optional Features for ZA-37 Penetrant System

Part #:	Description:
609178RE-P	RE Lid, Tank
606333	ZA-37 dryer

NOTE: Dynamic Cloud (Dry Developer) design with dust collection and a 2.5 gallon pressure pot is now available. Standard ZA-37W, ZA-37E and ZA-37H models do not include dynamic cloud design.

Penetrant Wastewater Treatment System



MAGNAPURE™

MagnaPure™ is a fluorescent penetrant ozone wastewater treatment system used to reduce the FOG (fats, oils and greases) to less than 100ppm. This patent applied technology automatically processes penetrant wastewater while using minimal floor space (main cabinet is only 24" W x 40" L). It requires almost no maintenance - there are no filters to purchase, stock or change. It also eliminates the hauling expenses and bacteria and odor problems of penetrant wastewater.

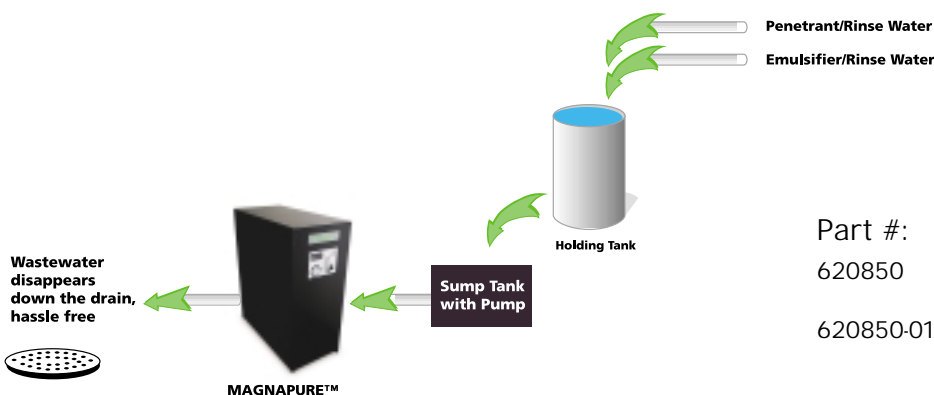

MAGNAPURE™

Specifications: Capable of processing penetrant wastewater. No replacement filters necessary, allows for discharge to drain (check with local Public Treatment Works Office).

Operating Temperature: The system will meet the stated specifications if the ambient operating temperature is between 40°F and 85°F.

Facilities Requirements: Power: Three Outlets; each 115v, 1 Phase, 60 Hz, 20 Amps.

Space Required: Approximately 16 square feet.

Benefits

- ▶ Requires minimal space (main cabinet is 24"W x 40"L)
- ▶ Maintenance is minimal
- ▶ Eliminates expenses for hauling penetrant wastewater
 - ▶ Eliminates bacteria and odor problems of penetrant wastewater
- ▶ No filters to purchase, stock or change
- ▶ AUTOMATICALLY processes penetrant wastewater
- ▶ Patent Applied Technology

Part #:	Description:
620850	MagnaPure™ 300: processing 300 gallons of penetrant wastewater per day
620850-01	MagnaPure™ 600: processing 600 gallons of penetrant wastewater per day

MAGNAGLO® / MAGNAFLUX®

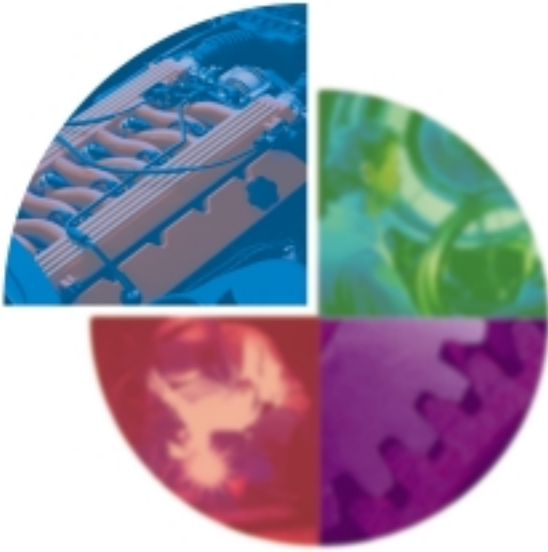

Magnetic particle inspection is a nondestructive inspection method used for detection of surface and subsurface flaws in ferrous parts. MPI inspection is used to inspect a variety of product forms such as castings, forgings, and weldments.

- ▶ *Dry and wet particles are available to suit your needs.*
- ▶ *Choose from fluorescent or non-fluorescent for UV or daylight inspection.*
- ▶ *Particle size is controlled to ensure maximum sensitivity.*
- ▶ *Fluorescent particles are encapsulated to minimize separation of fluorescence from particles.*

Benefits

Our magnetic particles are designed to hold up better and do not break down during agitation. This avoids having to change the bath as often and insures consistent performance during inspection.

The only requirement from an inspectability standpoint is that the component being inspected must be made of a ferromagnetic material such as iron, nickel or cobalt, or some of their alloys. Ferromagnetic materials are materials that can be magnetized to a level that will allow the inspection to be effective.

The **MAGNAGLO** product line is our fluorescent (requires a black light) wet method magnetic particle materials used in Magnetic Particle Inspection to locate surface and subsurface flaws in ferrous parts.

The **MAGNAFLUX** product line is our dry method, non-fluorescent magnetic particle materials used in Magnetic Particle Inspection to detect surface and subsurface flaws in ferrous parts.

Applications MAGNAGLO/MAGNAFLUX is used to detect flaws in the following:

- ▶ **Foundries**
- ▶ **Law Enforcement**
- ▶ **Lifting Devices**
- ▶ **Maintenance Shops**
- ▶ **Marine**
- ▶ **Military**
- ▶ **Pipelines**
- ▶ **Amusement Rides**
- ▶ **Automotive Components Manufacturers**
- ▶ **Automotive Rebuilders**
- ▶ **Fabrication Shops**
- ▶ **Railroads – Major Railway Systems & Local Transit Authorities**
- ▶ **Test Labs**
- ▶ **Tool Shops**
- ▶ **Utilities – Nuclear Power Plants & Electric and Gas Utilities**
- ▶ **Welding Shops**
- ▶ **Shipyards**
- ▶ **Ski Lifts**
- ▶ **Steel Mills**

Wet Method Fluorescent Magnetic Particles

14A

Fluorescent Particles

(to be mixed with Carrier II or Water/Additives)

14A is a dry, free flowing, brown magnetic powder which fluoresces bright yellow-green under black light. 14A is intended for use in high sensitivity wet method magnetic particle inspection. It may be suspended in either a petroleum-based vehicle (oil) such as MAGNAFLUX®/MAGNAGLO® Carrier II, or in water. When water is used as a vehicle, conditioning agents such as WA-2B, or WA-4 are required.

Suspension: Water/Oil

Recommended Concentration: 1/8 oz./gallon (1.25 grams/liter)

Part #:	Container Size:
01-0130-57	1 lb. Container
01-0130-71	Six Pack of 1 lb. Containers
01-0130-69	10 lb. Container
01-0130-75	20 lb. Container

14A Aqua-Glo™

Fluorescent Premix with Water

Fluorescent green prepared solution of 14A fluorescent particles in a water based medium designed to offer the benefits of water and the convenience of aerosol form.

Suspension: Water Only

Recommended Concentration: Comes as a prepared bath

Part #:	Container Size:
01-1725-38	Case of 12 Aerosols

20B Preblended Dry Mix Fluorescent Particles (14A+Additives)

20B is composed of fluorescent magnetic powder, nonionic surfactants, and corrosion inhibitors. It is a pre-blended dry mix of 14A magnetic powder and WA-2B water conditioner.

Suspension: Water Only

Recommended Concentration: 1.5 oz./gallon of water (11.25 grams/liter)

Part #:	Container Size:
01-0179-71	Six Pack of 1 lb. Containers
01-0179-70	15 lb. Container
01-0179-84	30 lb. Container

14AM

Fluorescent Premix with Carrier II

Fluorescent prepared bath of 14A powder and Carrier II (a high flash point petroleum vehicle). Ready to use without measuring and mixing.

Suspension: Oil

Recommended Concentration: Comes as a prepared bath

Part #:	Container Size:
01-0145-68	Case of 12 – 12 oz. Aerosols
01-0145-78	Case of 12 – 16 oz. Aerosols*
01-0145-40	5 Gallon Pail

14A Redi-Bath™

Fluorescent Premix Concentrate for Water

Preblended concentrate of our 14A fluorescent green magnetic particle powder, mixed with water, wetting agent and corrosion inhibitor.

Easiest method of water bath preparation. Simply add pre-blended concentrate to water.

Suspension: Water Only

Recommended Concentration: 2.7 oz./gallon (21 ml/liter)

Part #:	Container Size:
01-9130-41	6 pack of 27 oz. bottles

MG-3410

Fluorescent Particles to be Mixed with Water

The powder contains conditioners which improve the magnetic particle suspendibility, mobility and wetting of test part surface. No additional wetting or conditioning agents are required when MG-3410 is used.

Suspension: Water Only

Recommended Concentration: 1/8 oz./gallon (0.75 gram/liter)

Part #:	Container Size:
01-0199-84	30 lb. Container

MG-410

Fluorescent Particles

(to be Mixed with Carrier II or Water/Additives)

MG-410 is a dry, free flowing, green magnetic powder which fluoresces bright green under black light

Suspension: Water/Oil

Recommended Concentration: 1/8 oz./gallon of vehicle (0.75 gram/liter)

Part #:	Container Size:
01-0191-57	1 lb. Container
01-0191-69	10 lb. Container
01-0191-81	25 lb. Container

*16 oz. cans international only

Wet Method Visible Magnetic Particles

7C Black

Visible Particles

(to be mixed with Carrier II or Water/Additives)

Non-fluorescent black magnetic particles. Provides excellent color contrast on shiny or light colored surfaces.

Suspension: Water/Oil

Recommended Concentration: 1.25 oz./gallon (9.36 grams/liter)

Part #:	Container Size:
01-1116-66	8 lb. Container

9C Red

Visible Particles

(to be Mixed with Carrier II or Water/Additives)

Non-fluorescent red magnetic particles. Similar to 7C but preferred for good contrast on gray, black or dark surfaces.

Suspension: Water/Oil

Recommended Concentration: 1.25 oz./gallon (9.36 grams/liter)

Part #:	Container Size:
01-1132-66	8 lb. Container

7HF Black

Visible Premix with Carrier II

7C Black Powder premixed with Carrier II packaged in an aerosol can.

Suspension: Oil

Recommended Concentration: Premixed in Aerosols

Part #:	Container Size:
01-1580-68	Case of 12-12 oz. Aerosols
01-1580-78	Case of 12-16 oz. Aerosols*

9CM

Visible Premix with Carrier II

9C Red powder premixed with Carrier II packaged in an aerosol can.

Suspension: Oil

Recommended Concentration: Premixed in Aerosols

Part #:	Container Size:
01-1148-68	Case of 12-12 oz. Aerosols

WCP-2

White Contrast Paint

Part #:	Container Size:
01-2250-68	Case of 12-12 oz. Aerosols
01-2250-78	Case of 12-16 oz. Aerosols*

Oil Petroleum Vehicle

Carrier II

Oil Vehicle

Suspension Vehicle formulated for magnetic particle testing; odor-free, low-viscosity, high flash point.

Part #:	Container Size:
012122-40	5 Gallon Pail
012122-30	20 Gallon Drum
012122-45	55 Gallon Drum

*16 oz. cans international only

Dry Method Magnetic Particles

#1 Gray

General Purpose

General Purpose Dry Method Particles. Choose the color that offers the best contrast to the surface you are inspecting.

Part #:	Container Size:
01-1716-72	12 – 1 lb. Containers
01-1716-69	10 lb. – Pail
01-1716-81	25 lb. – Pail
01-1716-87	45 lb. – Pail

#2 Yellow

General Purpose

General Purpose Dry Method Particles. Choose the color that offers the best contrast to the surface you are inspecting.

Part #:	Container Size:
01-1732-69	10 lb. – Pail
01-1732-81	25 lb. – Pail
01-1732-87	45 lb. – Pail

#3A Black

General Purpose

General Purpose Dry Method Particles. Choose the color that offers the best contrast to the surface you are inspecting.

Part #:	Container Size:
01-1748-72	12 – 1 lb. Container
01-1748-69	10 lb. – Pail
01-1748-81	25 lb. – Pail
01-1748-87	45 lb. – Pail

#8A Red

General Purpose

General Purpose Dry Method Particles. Choose the color that offers the best contrast to the surface you are inspecting.

Part #:	Container Size:
01-1780-72	12 – 1 lb. Containers
01-1780-69	10 lb. – Pail
01-1780-81	25 lb. – Pail
01-1780-87	45 lb. – Pail

Water Bath Additives

AX-52

Corrosion Inhibitor

AX-52 is a Corrosion Inhibitor. Corrosion Inhibitors retard water's attack on the magnetic particles and thus extend bath life. They also help prevent corrosion of parts during processing and protect any exposed parts of inspection machinery. They are not designed to provide long-term corrosion protection for parts during storage after testing. When long term protection is required, an oil vehicle or separate anticorrosion treatment is recommended.

Form: Yellow Liquid

Recommended Concentration: 1% – 5% by Volume

Part #:	Container Size:
012190-40	5 Gallon Pail
012190-45	55 Gallon Drum

WA-4

Water Bath Additive

WA-4 consists of a Wetting Agent and Corrosion Inhibitor.

Form: Amber Liquid

Recommended Concentration: 1% by Volume

Part #:	Container Size:
012172-20	1 Gallon Jug
012172-40	5 Gallon Pail

WA-2B

Water Bath Additive

WA-2B is a wetting agent and corrosion inhibitor and antifoam water bath additive. Wetting Agents enable easier suspension of magnetic particles in water.

Form: White Granular Powder

Recommended Concentration: 1.33 oz./gallon (10 grams/liter)

Part #:	Container Size:
012148-63	5 lb. Container
012148-84	30 lb. Container

ZAF-2

Antifoaming Additive

Antifoaming agents suppress the natural tendency of any water bath to foam when agitated.

Form: Clear Liquid

Recommended Concentration: 3 – 5 Drops/15 gallons

Part #:	Container Size:
019410-20	1 Gallon Jug

Magnetizing Yoke and Coil Kits

Designed for one-person portable magnetic particle inspections of ferrous parts. Ideal for inspection of welds and other remote testing. Articulating, double-jointed legs of yokes contour to any part shape to assure good contact and lightweight coil makes handling easy.



a) Y-6 AC Yoke Kit

Part #	Includes
45291 – 115V	Y-6 Yoke, 1 lb. of #1 Gray Dry Powder, 1 lb. of #8A Red Dry Powder, 4 – Packets of Scrubs™, Powder Spray Bulb, Paint Marker, Wiping Cloth and Instructions. NEW – One Year Warranty
45292 – 230V	



Y-7 AC/DC Yoke Kit

Part #	Includes
43509 – 115V	Y-7 Yoke, 1 lb. of #1 Gray Dry Powder, 1 lb. of #8A Red Dry Powder, 4 – Packets of Scrubs™, Powder Spray Bulb, Paint Marker, Wiping Cloth and Instructions. NEW – One Year Warranty
620741 – 230V	

b) Y-8 Battery Powered Yoke Kit

Part #	Includes
611710	Battery Powered Yoke, Case, Charger and 1 lb. of #1 Gray Powder, Powder Spray Bulb. NEW – One Year Warranty



c) L-10 Coil Kit

Part #	Includes
50650	L-10 Coil (115 Volt – 50/60 hz) and Nonfluorescent Kit P/N 45293.

Non-fluorescent Materials Kit

Part #	Includes
45293	1 lb. #1 Gray, #3A Black and #8A Red powder; 1 aerosol can of 7HF, 9CM and WCP-2, powder bulb, field indicator, 2 cans SKC-S, instructions

For Yoke Operating Instructions see page 36.

MAGNAGLO® / MAGNAFLUX® Specification Conformance Chart

Wet Method Magnetic Particles

Specification	14A	14AM	14 Aqua Glo™	14A Redi-Bath™	20B	MG-410	7C Black	7HF Black	9C Red	9CM Red	Carrier II
NAVSEA T9074-AS-GIB-010/271	X		X	X	X	X	X		X		
MIL-STD-2132	X	X	X	X	X	X	X		X		
AMS 2641											X
AMS 3041								X		X	
AMS 3042							X		X		
AMS 3043								X		X	
AMS 3044	X		X	X	X						
AMS 3045		X									
AMS 3046		X									
ASME B & PV Code, Sec. V	X	X	X	X	X	X	X	X	X	X	X
ASTM E 709	X	X	X	X	X	X	X	X	X	X	X
ASTM E 1444	X	X	X	X	X		X	X	X	X	X
A-A-59230		X									X
Boeing PS-21201	X	X	X	X							
NAVSEA 250-1500-1	X		X	X	X	X	X		X		
Pratt & Whitney PMC 1887											X

Dry Method Magnetic Particles

Specification	1 Gray	2 Yellow	8A Red	3A Black
NAVSEA T9074-AS-GIB-010/271	X	X	X	X
MIL-STD-2132	X	X	X	X
AMS 3040	X	X	X	X
ASME B & PV Code, Sec. V	X	X	X	X
ASTM E 709	X	X	X	X
ASTM E 1444	X	X	X	X
NAVSEA 250-1500-1	X	X	X	X

MAGNETIC PARTICLE® ACCESSORIES

Contact Plates for Wet Horizontal Units

Copper braid pads and lead contact plates prevent burning by ensuring good electrical contact between test part and contact heads. Coils mount on rails of wet horizontal units for detection of transverse cracks on parts.

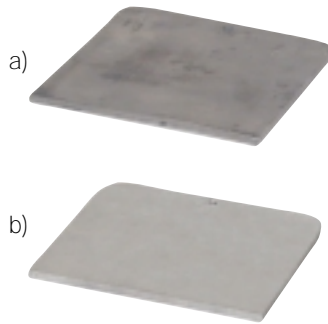

a) Lead Contact Plate

- ▶ Duplicates original headstock/tailstock contact plates
- ▶ Soft lead plate provides excellent contact
- ▶ ¼" x 6 ¾" x 6 ⅝"
- ▶ Fits all units except A-915 and MAG Series units

Part #: 605647

b) Heavy-Duty Lead Contact Plate

- ▶ Braided copper impregnated with lead
- ▶ Lasts up to 10 times longer than solid lead contact plates
- ▶ ¼" x 6 ¾" x 6 ⅝"
- ▶ Fits all units except A-915 and MAG Series units

Part #: 605657

Contact Pads for Wet Horizontal Units

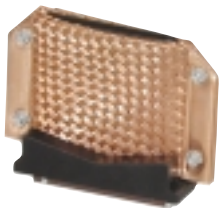

Double-Braided Pad with V-Block

- ▶ Heavy copper braid over neoprene base
- ▶ Molded-in V-block centers and supports test parts
- ▶ Flexible, provides contact over greater surface area
- ▶ Reversible – two wear faces
- ▶ Fits all units except A-915 and MAG Series units

Part #: 18948



Double-Braided Pad with Clip

- ▶ Similar to #18948, but clips over headstock of A-915 and MAG Series units

Part #: 18949



Replacement Pad

- ▶ Replacement pad for 18948 and 18949

Part #: 1848

Test Pieces



Continuous Method Test Block

- ▶ Quick, convenient check for proper magnetizing technique on wet horizontal units
- ▶ Crack indication forms on test block if current flow and bath concentration are adequate

Part #: 75130

Residual Method Test Block

- ▶ Similar to #75130 above, but for use with residual method

Part #: 153750



Magnetic Particle Test Bar

- ▶ Contains coarse and fine artificial surface and subsurface defects in both directions
- ▶ Meets or exceeds most industrial and military specifications for artificial test specimens, including MIL-STD-271

Part #: 189838

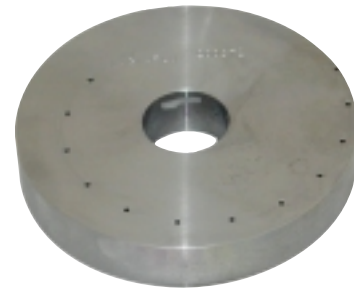

Tool Steel Test Ring

- ▶ Drilled holes simulate subsurface discontinuities
- ▶ Form surface indications at various magnetizing current levels
- ▶ Meets ASTM E 1444 requirements and certified to AS 5282

Part #: 159999



Pie Gauge

- ▶ The Magnetic Particle Pie Gauge is a device used as an aid in determining the direction of magnetic fields for detection of discontinuities in ferrous metals.

Part #: 169799

Test Pieces

QQI Test Pieces

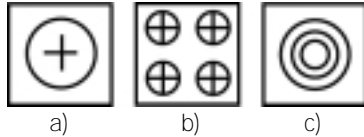

Quantitative Quality Indicators (QQI) are Magnetic Particle Test Pieces with Artificial Defects.

QQI's are used

- ▶ to increase productivity by minimizing magnetizing shots
- ▶ to verify field direction and relative strength
- ▶ to balance multi-directional fields

a) Standard QQI's

Basic circular and crossed bar flaw configuration suitable for longitudinal and circular fields.

Part #:	Model#	Description:
519630	KSC-230	Standard QQI, flaw depth of 30% of Shim thickness, .002" thick
521048	KSC-430	Standard QQI, flaw depth 30% of Shim thickness, .004" thick

b) Miniature QQI's

Similar to KSC-230, except miniature design for small areas on test part. The four circles may be cut apart for individual use.

Part #:	Model#	Description:
519631	KSC-4-230	Miniature QQI with four circles per sheet, flaw depth 30% of Shim thickness, .002" thick

c) Variable Depth QQI's

These QQI's are used for more quantitative work, three concentric circular flaws of differing depth.

Part #:	Model#	Description:
519632	KSCT-234	Variable depth QQI's, flaws 20%/30%/40% of Shim thickness, .002" thick
521049	KSC4-234	Variable depth flaws 20%/30%/40% of Shim thickness, .004" thick

Head Stock and Tail Stock Adaptors

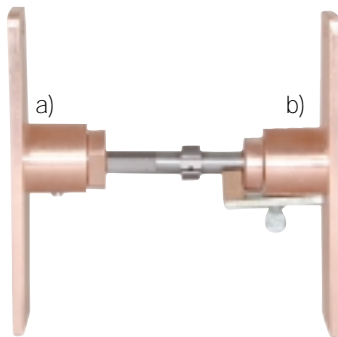

a) Small Parts Adaptor, Headstock

- ▶ Enables inspection of small parts such as bolts, screws and pins on wet horizontal units
- ▶ Solid copper, mounts to headstock

Part #: 28470

b) Small Parts Adaptor, Tailstock

- ▶ Enables inspection of small parts such as bolts, screws and pins on wet horizontal units
- ▶ Solid copper, mounts to headstock

Part #: 28471

Contact Block and Central Conductors

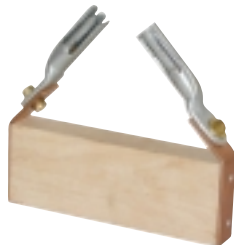

Contact Block

- ▶ When clamped between heads, supplies magnetizing current to remote prods or clamps through flexible cable (not included)
- ▶ Permits remote testing of parts that are too heavy or too large for processing on unit

Part #: 1830



Central Conductors

These solid copper rods provide circular magnetization of hollow parts. Three sizes are available.

Part #:	Size:
111203	¾" x 24"
111204	1" x 18"
111202	½" x 12"
111205	Set of Three: One each of 111202, 111203, and 111204

Field Indicators



Field Indicator

- ▶ Rugged, pocket-size meter used to indicate residual magnetism remaining in part after demagnetization
- ▶ Inexpensive unit cannot be recalibrated

Part #: 2480



20 Gauss Calibrated Indicator

- ▶ Accurate to ± 0.5 gauss. Scale range of 20-0-20

Part #: 105645



10 Gauss Calibrated Indicator

- ▶ Offers highly accurate measurement of residual leakage field in parts after demagnetization
- ▶ Accurate to ± 0.3 gauss. Scale range of 10-0-10

Part #: 505056



Digital Hall Effect Probe Gaussmeter

- ▶ Hand-held meter measures AC and DC magnetic field strength in Gauss
- ▶ Includes meter, transverse probe, zero gauss chamber, four "9 Volt" batteries, operation manual and carrying case
- ▶ Axial probe (#521045) available as an option

Part #: 521043

Centrifuge Tubes

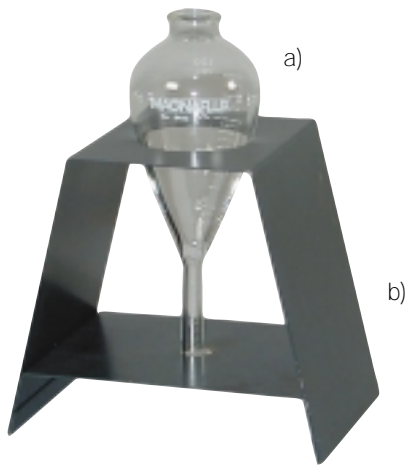

With MAGNAFLUX centrifuge tubes, you can monitor the concentration and level of contamination of magnetic particles in MAGNAFLUX or MAGNAGLO baths.

14A Centrifuge tube shown with stand (sold separately).

a) 14A Centrifuge Tube

- ▶ 100 ml, 0 – 1.0 ml in 0.05 increments
- ▶ For use with #14A, #14AM and #20B MAGNAGLO fluorescent materials

Part #: 8493

7C/9C Centrifuge Tube

- ▶ 100 ml, 0 – 1.5 ml in 0.10 increments
- ▶ For MAGNAFLUX color-contrast materials including #7C, #9C and #9CM

Part #: 2461

b) Centrifuge Stand

- ▶ Safely holds centrifuge tubes when mixing bath concentrations

Part #: 1837A

MG-410 Centrifuge Tube

- ▶ 100 ml, 0 – 0.2 ml in 0.01 increments
- ▶ For use with MG-410

Part #: 507923

Wet Particle Bath Sprayers



Portable Pressure Sprayer

- ▶ Easy-to-use, heavy-duty pressure sprayer is ideal for spot application of magnetic particle bath
- ▶ Features chrome-plated solid brass construction, one-quart capacity
- ▶ Pressurize with compressed air or with CO₂ cartridges to a maximum of 200 psi

Part #: 195260

Portable Powder Blower and Powder Spray Bulb



Portable Powder Blower

Part #: 620936



Powder Spray Bulb

- ▶ Lightweight, easy-to-use spray bulb for applying MAGNAFLUX dry powders
- ▶ Cap removes for easy filling

Part #: 501232

Monitoring Devices

Easy-to-use test meters verify the accuracy of the built-in ammeter of standard wet horizontal magnetic particle units and power packs.



Digital Test Meter Kit

- ▶ For all AC, Full Wave and Half Wave DC (FWDC & HWDC) wet horizontal units
- ▶ For all portable, mobile, stationary and multi-directional power packs up to 20,000 amps
- ▶ Includes calibrated meter, shunt, leads, operating instructions and carrying case with shoulder strap

Part #: 600355



Analog FW Test Meter

- ▶ For FWDC wet horizontal units and stationary power packs up to 6,000 amps

Part #: 10090

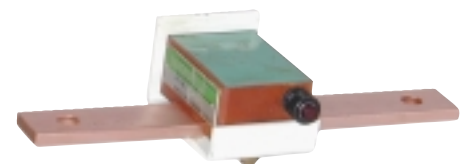

Quick Break Tester

- ▶ Quickly and accurately confirms function status of "quick break" circuitry in three phase FWDC magnetic particle units
- ▶ Manufactured for compliance to ASTM E 1444

Part #: 148335

Prod Sets

Hand-held electrodes enable magnetizing current to pass through sections of welds, castings, forgings and large fabrications.

All prod sets:

- ▶ Require additional power cables, purchased separately
- ▶ Include either solid tips (for maximum wear) or braid tips (for better contact) and 20' control cable with trigger in handle
- ▶ Available with either 3 PTL plug for P-Series or 4 PTL plug for M-Series, CSQ and CSV Series power packs



Standard Prod Set

- ▶ Individual contact prods offer maximum flexibility in prod spacing and magnetizing of complex-shaped parts
- ▶ With 3 PTL plug for P-Series portable power packs

Part #:	Description
157662	3 PTL plug
157660	4 PTL plug*

*Use with Stationary Power Pack Prod Sets (M and C Series)

Dual Horizontal Prod Assembly

- ▶ Offers one-person operation with variable prod spacing (4" – 8")
- ▶ With 3 PTL plug for P-Series portable power packs

Part #:	Description
157781	3 PTL plug
157780	4 PTL plug*

Braided Tip Prod Set

- ▶ Similar to #157662, but with braid tips for better contact
- ▶ With 3 PTL plug for P-Series portable power packs

Part #:	Description
186195	3 PTL plug
186194	4 PTL plug*

*Use with Stationary Power Pack Prod Sets (M and C Series)

Dual In-Line Prod Assembly

- ▶ Offers one-person operation and variable prod spacing (3" – 6")
- ▶ With 3 PTL plug for P-Series portable power packs

Part #:	Description
157087	3 PTL plug
157088	4 PTL plug*

Braided Conversion Assembly

- ▶ Adapter converts solid tips to braid tips – two required

Part #: 186202

Remote Cable/Palm Button



Remote Control Cable, 15'

- ▶ Allows remote energization of portable power packs
- ▶ Standard with 3 PTL plug

Part #: 157657



Remote Palm Button

- ▶ Mounts on side of MAG Kit for energizing current from power pack
- ▶ Standard with 3 PTL plug

Part #: 169621

Publications



Demagnetizing Techniques Videotape

- ▶ Informational and educational video on demagnetizing techniques

Part #: 520586



Principles of MPI Testing Book

- ▶ "Principles of Magnetic Particle Testing" by C.E. Betz explains the fundamental concepts, basic techniques and procedures and various methods of magnetic particle testing

Part #: 517422



QOI's in Action Videotape

- ▶ Informational and demonstrational video on QOI's (artificial defects)

Part #: 520584

Cables and Connectors

Rubber-covered flexible cables are available in standard lengths of 15' and 20' with your choice of eitherend or lug connectors. Individual connectors to replace those worn or damaged in use are also available.

Standard 4/0 Cable Assemblies

Part #:	Length (Feet):	Fittings:
11306	15	Lugs at both ends
11307	15	Lug and eitherend
11308	15	Eitherends at both ends
11312	20	Lugs at both ends
11313	20	Lug and eitherend
11314	20	Eitherends at both ends

Custom 4/0 and 1 million circular mill cable assemblies are also available.



4/0 Eitherend Connector

- ▶ Allows quick cable disconnect for maximum flexibility

Part #: 1238



4/0 Lug

- ▶ For permanent attachment to magnetizing equipment

Part #: 2590



Eitherend Lug Adaptor

- ▶ Changes lug terminals to eitherend terminals

Part #: 1574



Eitherend Lug Adaptor, 90°

- ▶ Similar to #1574, but at a 90° angle

Part #: 1576

Contact Clamps



Spring Loaded Contact Clamp

- ▶ Specifically designed for more accurate inspection of tubing, bars and tubular assemblies, such as aircraft engine mounts and fuselage sections
- ▶ Clamps connect via lugs and flexible cables to electrical terminals of portable units or contact blocks (#1830) on bench units
- ▶ For 1 1/4" to 2 1/2" diameter parts
- ▶ Replacement Copper Braid (#14710) also available

Part #: 1865A

Heavy-Duty Contact Clamp

- ▶ Similar to #1865A, but for parts up to 7" diameter

Part #: 169802



Split Coils

Our multiple-loop, quick-connect cable-coil saves time, eliminates complicated coil winding and is particularly useful when inspecting heavy equipment, rolling stock and heavy machinery.

Part #:	Size:
14725	12" diameter 4/0 cable with eitherends
14726	18" diameter also available
14727	24" diameter also available



Magnetic Leech

- ▶ Permanent magnet with 4/0 eitherend connector attaches to part, freeing a hand to enable one-person prod operation

Part #: 54975

Steadyrests and Raising Blocks

To support long or heavy parts such as crankshafts during inspection, choose from the following selection of MAGNAFLUX steadyrests and raising blocks.



Rail-Mounted Roller-Type Steadyrest

- ▶ Mounts and moves on rails to accommodate various part lengths
- ▶ A pair increases weight capacity from 300 to 1500 lbs
- ▶ Adjustable height
- ▶ Fits all units except the A-915 and MAG Series units

Part #: 1857

NOTE: Also order "Raising Block" 14786 if used with 16", 20" or 25" coil.



Headstock-Mounted Roller-Type Steadyrest

- ▶ Mounts on headstock to support one end of part (Use rail-mounted steadyrest #1857 to support other end)
- ▶ Facilitates part loading as coil may be retracted past headstock
- ▶ Fits all current models except the A-915 and MAG Series units

Part #: 605750



MAG Kit Pump

- ▶ To be used with the MAG Kit bench unit
- ▶ Provides continuous spray and re-capture of MAGNAGLO bath
- ▶ Includes hose, nozzle, fittings, 5-gallon pail
- ▶ Operates on standard 115V, 50 – 60 Hz, single phase line current

Part #: 69390



Flat Magnetizing Coil

- ▶ Accessory for use with any magnetic particle unit or power pack
- ▶ Non-contact method of applying field
- ▶ Allows for quick, easy processing of several small parts at one time, such as fasteners, ring-like parts

Part #: 611700

Coil for Bench Units

- ▶ 5-turn coils in various diameters for all units, except A-915 and MAG III Series units



Part #:	Size:
28501	12" Coil
28511	16" Coil
28531	20" Coil
28541	25" Coil

Coil Base

- ▶ For use with coils on all units, except for A-915 and MAG Series units

Part #: 26193

MAGNETIC PARTICLE EQUIPMENT

Yokes

Benefits

- ▶ Portable lightweight yokes for one-person inspection in tight places
- ▶ Adjustable legs enable you to inspect many different surface configurations
- ▶ **NEW!!**
One Year Warranty

MAGNAFLUX Yoke and Coil Kits

MAGNAFLUX Yoke Kits are designed for reliable, one person magnetic particle inspection of ferrous parts when portability is essential. Because the kits are portable and the yokes fit into tight places, they are ideal for in-plant structures and field work. MAGNAFLUX offers a variety of options, so you can select exactly what you need – a yoke only, or a kit that also includes testing materials and accessories.

Whether you choose a Y-6 AC yoke to locate surface cracks or a Y-7 AC/DC yoke to find surface and near-surface defects or a Y-8 battery powered yoke for portability, you always get unsurpassed MAGNAFLUX quality and reliability.

- ▶ Articulating, double-jointed legs contour easily to any part shape to assure good contact.
- ▶ Pull force (60 lbs DC, 10 lbs AC) complies with specifications.
- ▶ Solid state controls located in housing for maximum safety and reliability.
- ▶ 2-minute ON/OFF duty cycles for fast, efficient inspections (Y-6 and Y-7).
- ▶ 30-second ON/OFF duty cycle - Y-8.

Operating Instructions

When yoke is connected to a proper power source and energized, an intense longitudinal magnetic field is created in the area between the yoke legs. Any surface cracks will create flux leakages which will attract magnetic particles that form indications that allow for detection.

There are two testing methods:

MAGNAFLUX Dry Non-Fluorescent Method, used with a yoke, does not require a black light and is more sensitive for finding near-surface defects on components with rough surfaces, such as castings and forgings.

MAGNAGLO Wet Fluorescent Method, used with a yoke and an ultraviolet black light, can find very fine surface flaws or slightly near-surface discontinuities (with Y-7 or Y-8 yokes only).

How to use

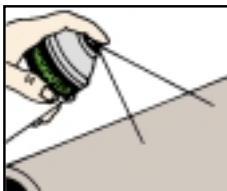

Preclean inspection area. Spray on Cleaner. Wipe off with cloth.

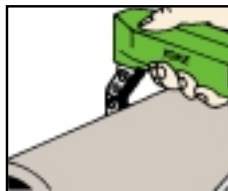

Place Yoke on test piece perpendicular to direction of suspected cracks.

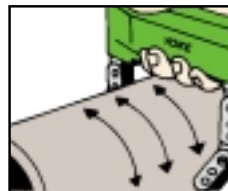

Energize Yoke. Magnetic field will form in test piece.



Apply magnetic powder or prepared bath while Yoke is energized.



Indications will form immediately.



Y-8 Battery Powered Yoke

Yoke:	Y-8 Battery Powered Yoke ONLY* (Part #620145) *Must choose the appropriate voltage for the battery charger.
Battery Charger:	115v Charger (Part #620142) 230v Charger (Part #620709)
Current Draw:	4 amps @ 6 volts DC (Yoke Only)
Current Draw:	0.2 amps @ 115v or 230v (Charger Only)
Demag:	No
Yoke Weight:	7 ¾ lb.
Leg Capacity:	0" – 12" (0-30 cm) across poles
Cord:	12 ft., coiled

BATTERY SPECIFICATIONS

Rechargeable Battery:	6 volt, 12-amp hour
Battery Weight:	5 ¼ lb.

Y-6 AC Yoke



Yoke:	115v, 50/60 Hz (Part #43530) or 230v, 50/60 Hz (Part #43540)
Current Draw:	Less than 9 amps @115v Less than 4 amps @230v
Demag:	Yes
Yoke Weight:	7.3 lbs (3.1 kg)
Leg Capacity:	0" – 12" (0-30 cm) across poles
Cord:	12 ft (365.8 cm) with grounded plug
Other:	Carrying case and instructions

Y-7 AC/DC Yoke



Yoke:	115v, 50/60 Hz (Part #43550) or 230v, 50/60 Hz (Part #43560)
Current Draw:	9 amps @ 115v AC 4 amps @ 115v DC 4 amps @ 230v
Demag:	Yes
Yoke Weight:	7.4 lb 115v (3.6 kg) 7.2 lb 220v (3.27 kg)
Leg Capacity:	0" – 12" (0-30 cm) across poles
Cord:	12 ft (365.8 cm) with grounded plug
Other:	Carrying case and instructions

Coils



L-10 Coil

- ▶ For detection of surface cracks
- ▶ 10" coil I.D., 15" coil O.D.
- ▶ Wear-resistant neoprene coating
- ▶ Equipped with footswitch for energizing magnetic current
- ▶ 10' flexible line cable
- ▶ 115V, 60Hz, single-phase power source required

Part #: 50651

Portable Power Packs



P-SERIES

For convenient, economical inspection in a wide range of magnetic particle applications that require only moderate power. For large or heavy parts, in-service mobile equipment, or job-site welds, portable power packs are the ideal choice.

Features:

- ▶ Find surface defects with AC current; switch cable connection to halfwave DC (HWDC) for near-surface flaws
- ▶ Locate defects in any direction using prods, central conductor, or coil (wrap part with 3-5 turns of cable)
- ▶ Infinitely variable current control
- ▶ Demagnetize part in AC mode by slowly turning the current dial to zero
- ▶ Built-in automatic-reset circuit breaker

Specifications

	Model P-70	Model P-1500
Length	17 1/2" (44.5 cm)	21 1/2" (54.9 cm)
Width	9 1/16" (23 cm)	9 1/32" (23.7 cm)
Height	7 13/16" (19.8 cm)	9 17/32" (24.2 cm)
Maximum output*	750 amps, AC or HWDC	1500 amps, AC or HWDC
Current input, single phase	115 VAC, 50/60 Hz; 230 VAC, 50/60 Hz (other voltages available)	230 VAC, 50/60 Hz; 460 VAC, 50/60 Hz (other voltages available)
Line current	26 amps @ 115 VAC; 13 amps @ 230 VAC	42 amps @ 230 VAC; 21 amps @ 460 VAC
Maximum duty cycle	2 minutes ON 2 minutes OFF	2 minutes ON 2 minutes OFF
Unit weight	35 lbs (15.9 kg)	93 lbs (42.2 kg)

* Current ratings based on the use of two 15-foot lengths of 4/0 cable.

Recommended Operating Accessories:

4/0 Cable Assemblies*, Prods Sets* Powder Spray Bulb (#501232), Pie Field Indicator (#169799), Flat Magnetizing Coil (#611700), Remote Control Cable (#157657), 5' Cable with Eitherends (#11308), and Remote Palm Button (#169621)

* Various sizes/styles available – check out our website

Part #:	Model:	Voltage:
190575	P-70	115V
190575-1	P-70	230V
198500	P-1500	Specify 230V or 460V

Mag Kit



Standard Mag Kit

39 Inch Head Opening, 11 Inch Coil (#69420) and Separate Power Supply (Must purchase either P-70 or P-1500 Portable Power Pack to energize the MAG Kit).

Part #:	Description:
69360-11	Standard Mag Kit 39" Head Opening, 11 Inch Coil (#69420) and Separate Power Supply (must purchase either P-70 or P-1500 Portable Power Pack to energize the MAG Kit).

Demagnetizer Equipment



S-66 Demagnetizer

The S-66 Demagnetizer is a fast, effective, dependable piece of demag equipment. This equipment is created specifically for volume demagnetizing of small parts on a production line.

Part #:	Description:
197250	S-66 Continuous Duty Demagnetization Coils Opening Size: 6" x 6" Opening (15 cm x 15 cm) Ampere Turns: 4,600; Voltage: 115v - 50-60/1
197251	S-66 Continuous Duty Demagnetization Coils Opening Size: 6" x 6" Opening (15 cm x 15 cm) Ampere Turns: 4,600; Voltage: Specify 230V or 460V



S-1212 Demagnetizer

The S-1212 Demagnetizer is a fast, effective, dependable piece of demagnetization equipment. This equipment is created specifically for volume demagnetizing of small parts on a production line. The S-1212 has a larger opening than the S-66, allowing for larger parts to be demagnetized.

Part #:	Description:
197260	S-1212 Continuous Duty Demagnetization Coils Opening Size: 12" x 12" (30 cm x 30 cm) Ampere Turns: 7,500; Voltage: Specify 230V or 460V

DARACLEAN® CLEANERS



DARACLEAN® cleaners are safe and effective against a wide range of soils. The DARACLEAN Product Line consists of concentrated cleaning agents, ranging from neutral to alkaline. These cleaners are formulated to remove a broad spectrum of soils from metals and non-metallic materials.

Benefits

The DARACLEAN product line represents the leading edge in aqueous cleaning technology.

- ▶ *Longer Bath Life*
- ▶ *Unique Self-Cleaning Ability*
- ▶ *Approved to Major OEM Specifications*
- ▶ *DARACLEAN can be used to replace vapor-degreasing solvents without major capital equipment expenditures.*
- ▶ *Water Based Cleaners ranging from Neutral to Alkaline*
- ▶ *Nonflammable*
- ▶ *Excellent Rejection Chemistry*

Applications

DARACLEAN cleaners are used successfully:

- ▶ *Prior to painting*
- ▶ *Prior to assembly*
- ▶ *Prior to plating*
- ▶ *Prior to anodizing*
- ▶ *For in-process cleaning*
- ▶ *For precision cleaning*
- ▶ *For sump cleaning*

Soils readily removed with DARACLEAN include (but are not limited to):

- ▶ Dye penetrants
- ▶ Cutting oils
- ▶ Fingerprints
- ▶ Mill markings
- ▶ Shop dirt
- ▶ Grease
- ▶ Carbon
- ▶ Coolants
- ▶ Waxes
- ▶ Rust preventatives
- ▶ Water-based paints
- ▶ Road soils and grime

Selecting an Aqueous Cleaning Process

Cleaning effectiveness is influenced by four primary variables as follows:

$$\text{Concentration} \times \text{Temperature} \times \text{Time} \times \text{Mechanical Action} = \text{CLEAN}$$

Usually if one variable is fixed, cleanliness can be accomplished by adjusting one or more of the other variables. Note that an increase or decrease may be needed.

Factors to Consider

- ▶ *Substrates Involved*
- ▶ *Size and Shape Variations*
- ▶ *Time and Temperature Restrictions*
- ▶ *Chemical Restrictions*
- ▶ *Water Source and Quality*
- ▶ *Specification Conformance Needs*
- ▶ *Degree of Cleanliness Needed*
- ▶ *Rinsing Requirements*
- ▶ *Next Manufacturing Process Step*
- ▶ *Drying Requirements*

Application Options

Cleaning is accomplished by a variety of methods including:

- ▶ **Manual Applications** *Hand Wiping, Brushing, Mopping*
- ▶ **Immersion Methods** *Soak, Agitation, Ultrasonics, Electrocleaning*
- ▶ **Vibratory** *Auger, Tumbling, Media Tumbling*
- ▶ **Spray Washing** *Cabinet, Tunnel, Wand*

DARACLEAN Recommended Operating Ranges

Method/Mechanical Action:	Concentration:	Temperature:	Time:
Soak	5-30%	80-180° F	2-30 min.
Agitation	5-30%	80-180° F	2-30 min.
Spray	2-15%	130-180° F	5-30 min.
Ultrasonic	5-30%	80-180° F	2-30 min.



DARASOLV 7

Neutral pH aqueous cleaner designed for heavy-duty cleaning of viscous oils, grease, light carbonaceous soils, waxes and some inks, resins and adhesives from most metal, glass, ceramic, plastic and rubber parts.

Part #:	Container Size:
01-6170-45	55 gallon
01-6170-40	5 gallon

DARASOLV 11

Heavy-duty aqueous alkaline cleaner for removal of heavy oils, greases and light, carbonized soils from most metal, plastic and ceramic surfaces.

Part #:	Container Size:
01-6200-45	55 gallon
01-6200-40	5 gallon

DARASOLV 14

Heavy-duty aqueous caustic cleaner for removal of carbonized oils and greases from ferrous, stainless and copper parts. Darasolv 14 can also be used as an etchant for aluminum and other soft metals.

Part #:	Container Size:
01-6230-45	55 gallon
01-6230-40	5 gallon

DARACLEAN 121

Mild, alkaline aqueous blend of organic surfactants and inhibitors. All ingredients are FDA approved for indirect contact with food according to 21CFR 178.3400. Effective on uncured ink and rubbers. May be applied by coarse spray, brush or immersion methods.

Part #:	Container Size:
01-6140-45	55 gallon
01-6140-40	5 gallon

DARACLEAN 200

Heavy-duty, low-foaming, all-purpose aqueous cleaner designed for spray immersion or ultrasonic applications. Not recommended on aluminum or other soft alloys that are adversely affected by caustic alkalis.

Part #:	Container Size:
01-6020-45	55 gallon
01-6020-40	5 gallon

DARACLEAN 203

Moderate, low-foaming heavy-duty caustic cleaner.

Part #:	Container Size:
01-6100-45	55 gallon
01-6100-40	5 gallon

DARACLEAN 211

Mild, all-purpose aqueous alkaline cleaner. Effective on greases, waxes and petrolatum. Aerospace qualified.

Part #:	Container Size:
01-6130-45	55 gallon
01-6130-40	5 gallon

DARACLEAN 232

Moderate foam, all-purpose, aqueous alkaline cleaner. Effective on greases, waxes and petrolatum.

Part #:	Container Size:
01-6070-45	55 gallon
01-6070-40	5 gallon

DARACLEAN 235

Very mild, low-foaming aqueous alkaline cleaner designed for spray or ultrasonic applications. It is a concentrated liquid blend of organic surfactants and inhibitors.

Part #:	Container Size:
01-6050-45	55 gallon
01-6050-40	5 gallon

DARACLEAN 236

Very mild, low-foaming aqueous alkaline cleaner designed for immersion, spray or ultrasonic applications. It is a concentrated liquid blend of organic surfactants and inhibitors.

Part #:	Container Size:
01-6040-45	55 gallon
01-6040-40	5 gallon

DARACLEAN 238

High pH, moderate-foaming aqueous cleaner designed for immersion or ultrasonic applications. This product is a concentrated liquid blend of silicates, phosphates, organic surfactants and inhibitors. Effective on a broad spectrum of greases and oils, safe for most metal substrates. Conforms to Boeing BAC 5763.

Part #:	Container Size:
01-6080-45	55 gallon
01-6080-40	5 gallon

DARACLEAN 257

Concentrated liquid blend of silicates, phosphates, organic surfactants and inhibitors. Effective on carbon, greases and oils. Safe on most metal substrates. Ideal for use in auto rebuild applications. Military approval. There is a NSN assigned for this product.

Part #:	Container Size:
01-6090-45	55 gallon
01-6090-40	5 gallon

DARACLEAN 259

Alkaline, low-foaming, all-temperature, aqueous cleaner designed for immersion, spray or ultrasonic applications. Concentrated liquid blend of silicates, organic surfactants and inhibitors.

Part #:	Container Size:
01-6160-45	55 gallon
01-6160-40	5 gallon

DARACLEAN 282

High pH, low-foaming aqueous cleaner designed for immersion, spray or ultrasonic applications. Concentrated liquid blend of silicates, organic surfactants and inhibitor. Conforms to Boeing BAC 5763 and numerous other aerospace specifications. NSN assigned.

Part #:	Container Size:
01-6000-45	55 gallon
01-6000-40	5 gallon

DARACLEAN 282GF

High pH, low-foaming aqueous cleaner designed for immersion, spray or ultrasonic applications. Concentrated glycol-free liquid blend of silicates, organic surfactants and inhibitors. Effective on a broad spectrum of metal substrates. Conforms to numerous aerospace specifications and is listed on MIL-C-29602. NSN have been assigned for this product.

Part #:	Container Size:
01-6010-45	55 gallon
01-6010-40	5 gallon

DARACLEAN 283

Heavy-duty, low-foaming, all-purpose, aqueous cleaner designed for spray, immersion or ultrasonic applications. This product has a unique self-cleaning ability that enhances filtration effectiveness. This product has Pratt & Whitney approval and conforms to Boeing BAC 5749. This product may be used as a CFC or VOC alternative. Users experience superior bath life which results in less downtime and increased production.

Part #:	Container Size:
01-6060-45	55 gallon
01-6060-40	5 gallon

CORROSION INHIBITOR 615

Amine blend of rust inhibitors specifically formulated to provide short term (up to 30 days) indoor in-process storage protection of ferrous and non-ferrous surfaces. This product may be applied via immersion or spray methods.

Part #:	Container Size:
01-6120-45	55 gallon
01-6120-40	5 gallon

ANTIFOAM DF-2

An anti-foaming agent designed to be added sump-side to control foam in aqueous cleaning systems. It is a concentrated organic blend of emulsifiers and silica. The use of DF-2 will not adversely affect paint adhesion; it will not cause "fish-eyes" or other imperfections in coated surfaces.

Part #:	Container Size:
01-6210-45	55 gallon
01-6210-40	5 gallon

MAGNAVU® CLEANERS

MAGNAVU Cleaner has been tested in both the pre-cleaning and post-cleaning phases of NDT. It is important to rinse the part thoroughly after cleaning to remove any residue. If a part is not rinsed prior to fluorescent penetrant processing, it can affect the ability to find the defect and the brightness of the indications. Available in Dip or Spray.

	Part #:	Container Size:
MAGNAVU (Dip)	01-5731-45	55 gallon
MAGNAVU (Dip)	01-5731-40	5 gallon
MAGNAVU (Spray)	01-5733-45	55 gallon
MAGNAVU (Spray)	01-5733-40	5 gallon

DARACLEAN® and MagnaVu® Specification Conformance Chart

Specification	DARACLEAN											MagnaVu
	DF-2	200	203	212	235	236	238	257	282	282GF	283	
Allied Signal EMS53170												X
AMS 1526; Aircraft Exterior Surfaces				X*	X*		X	X	X	X	X*	
AMS 1537; Alkaline Hot Tank Cleaner									X			
ARP 1511; Low-embrittling Cd Plate				X	X		X	X	X	X	X	
ARP 1512; Sandwich Corrosion				X	X	X	X	X	X	X	X*	
ARP 1755; Stock Loss				X	X	X	X	X	X	X	X	
ASTM F-331; Nonvolatile Residue (NVR)				X	X							
ASTM F-483 Immersion Corrosion				X	X*	X	X	X	X	X	X*	
ASTM F-484; Stress Craze Acrylics Plastics				X	X	X	X	X	X	X	X	
ASTM F-485 Unpainted Aircraft Surfaces				X	X	X	X	X	X	X	X	
ASTM F-502; Painted Aircraft Surfaces				X	X	X	X	X	X	X	X	
ASTM F-519; Hydrogen Embrittlement				X	X		X	X	X	X	X	
ASTM F-945; Titanium Stress				X	X	X	X	X	X	X	X	
ASTM F-1110; Sandwich Corrosion				X	X	X	X	X	X	X	X*	
ASTM F-1111; Low-embrittling Cd Plate				X	X		X	X	X	X	X	
Allied Signal; EMS 53170; AQ/Semi-Aq. Degreaser									X			
Boeing BAC 5749; Alkaline Cleaning											X	
Boeing BAC 5763; Emulsion Aqueous Cleaning				X	X		X		X			
Boeing BAC 5763, PSD 6-26; Oxygen Systems				X								
Boeing BAC 5763, PSD 6-36; Type II Spray Deg.				X								
Boeing BAC 5763, PSD 9-3; Oxygen Systems				X								
Boeing BAC 5763, PSD 9-10; Oxygen Systems					X							
Boeing D6-48809; Sandwich Corrosion				X	X	X	X	X	X	X	X*	
Douglas CSD#1; General Purpose Cleaner				X	X		X	X	X			
Canadair; BW: 92/333									X			
Douglas Helicopter; HMS20-1267/2125								X				
Douglas Helicopter; HMS20-1267/2127								X				
Douglas MD P.S. 12024							X					
GEAE Method 22; 70-21-22									X	X		
GEAE CT-882; Heat Corrosion								X				
Lockheed ADC; G32001							X					
Lockheed STM32-301												X
Mil-C-29602; Cleaning Compounds										X		
Pratt & Whitney PMC 1438						X						
Pratt & Whitney PMC 1445	X											
Pratt & Whitney PMC 1421											X	
Pratt & Whitney PMC 1429; Alk. Cleaner-Spray									X			
Pratt & Whitney PMC 1435 (Dip)												X
Pratt & Whitney PMC 1439 (Spray)												X
Pratt & Whitney PWA 36604; Hot Corrosion						X	X			X	X	X
Pratt & Whitney PWA 36604; Non-metallics						X	X	X		X		X
Pratt & Whitney PWA 36604; PWA 407 Rubber						X	X	X		X		
Raytheon; MP-921									X			
SCAQMD Certification		X		X		X	X	X		X		
Sundstrand Data; #037-0228-000									X			
96 Hr. Acute Aquatic Toxicity						X						

* Some restrictions apply

BLACK LIGHTS

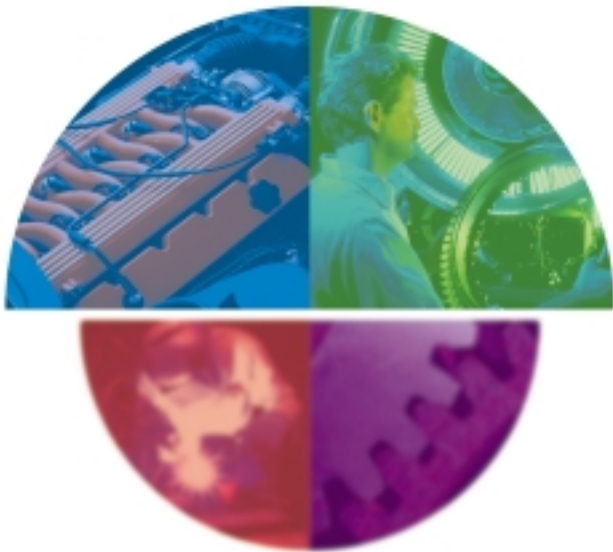

ZB-100F
Portable Black Light System
produces longwave ultraviolet
light at 365 nanometers,
providing optimum fluorescence
in MAGNAGLO® and ZYGLO®
testing materials.

- ▶ 100 watt black light with transformer, cords, GFCI and plug.
- ▶ Built-in fan keeps light cool-to-the-touch.
- ▶ Running temperature <85°F.
- ▶ Typical output 5,000 $\mu\text{W}/\text{cm}^2$.
- ▶ #600004 portable unit includes carrying base and stand for storage of cord.
- ▶ #600005 Hand-held unit similar to #600004, except no carrying base provided.

Benefits

One significant feature that separates the ZB-100F from other black lights – it has a built-in, quiet-operating DC fan located at the rear of the lamp housing.

The advantage of this design feature is obvious – dramatically reduced running temperature. In practical terms, the fan-cooled ZB-100F means more comfort and safety for operators plus longer bulb life.

Because black lights are often hand-held during fluorescent inspections, the heat they create is an important consideration. The typical running temperature of the ZB-100F is less than 85 degrees Fahrenheit, so it does not significantly raise the ambient temperature around the operator, nor is it a safety concern.

The ZB-100F also shares all of the features of the ZB-100, our most popular NDT black light.

- ▶ Polycarbonate Air-Flo™ bezel allows air to cool lens in the rest position, and helps keep operators' hands away from lens glass during use
- ▶ Cord-through-handle design reduces operator fatigue, improves balance and provides greater safety
- ▶ Fiberglass-reinforced handle always stays cool
- ▶ Tough aluminum housing withstands rugged use
- ▶ Recessed lens design protects lens and bulb from damage



part # 600004

ZB-100F Hand-Held, Fan-Cooled Black Light

Part #:	Voltage:
600004	115v/60 Hz/1ph with carrier/stand
600005	115v/60 Hz/1ph
600076	230/50-60/1ph with carrier/stand
600068	Carrier/stand for ZB-100F

ZB-100 Black Light

- ▶ 100 watt, hand-held model includes transformer, cords, GFCI and plug.
- ▶ 115v 60 hz
- ▶ Typical intensity @15" (38 cm): 4300 Microwatts/cm²
- ▶ Plastic Air-Flo™ Bezel protects operators from burns

Part #:	Voltage:
600000	115v/60 Hz/1ph
600001	230v/60 Hz/1ph
600002	230v/50 Hz/1ph
600003	115v/50 Hz/1ph
047685	Carrying Case for ZB-100 (Case does NOT fit ZB-100F)

NEW!



ZB-100F MB – MAG Shot Black Light

We have taken our ZB-100F Fan-Cooled black light and added the convenience of energizing your Power Packs or Wet Benches REMOTELY, when checking for cracks in extra long parts.

Our ZB-100F MB has a remote button integrated into the handle of the black light to eliminate the need to continuously return to the MPI Unit to initiate a mag shot.

Part #: 600086

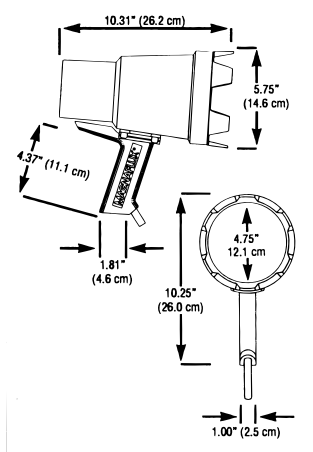

Technical Specifications for ZB-100F

- ▶ **Power Supply:** 115V/50 or 60Hz/1ph
ZB-100F 115v/60 Hz/1ph (P/N 600005)
ZB-100F 230/50-60/1ph (P/N 600076)
- ▶ **Current Draw:** 1.9 amps
- ▶ **Typical Visible Light:** 10 Lux or 1 foot candle @ 15" (38 cm)
- ▶ **Bulb:** 100 watts
- ▶ **Running Temperature:** 85°F (30°C) @ 70°F 13 amps @230 VAC
- ▶ **Weight – Hand Lamp:** 3 lbs. (1.4 kg)
- ▶ **Weight – Hand Lamp with Transformer:** 12.5 lbs. (5.7 kg) Control Unit
- ▶ **Lamp to Transformer:** 10 ft. (3.1 m) Cable Unit
- ▶ **Main Cable Supply:** 12 ft. (3.7 m) with Ground Fault Protection
- ▶ **UV Intensity meets industry and military standards @ 15" (38 cm)**

We also offer the following black lights:

BIB-150B Self-Ballasted Black Light System

- ▶ Longwave lamp with 150 watt concentrated spot, built-in-ballast bulb and 8' power cord
- ▶ Utilizes Built-In-Ballast black light bulb (P/N 519296), eliminating the need for an external transformer
- ▶ Stay-cool handle made of fiberglass-reinforced plastic

Part #: 519295

Hand-Held Tubular Black Light

- ▶ Lightweight, low-cost tubular design permits inspection of hard-to-reach areas
- ▶ Moderate intensity lamp provides good illumination when held 2" – 3" from inspection surface
- ▶ Uses two Tubular Bulbs – p/n 7272 (included with purchase of Black Light)

Part #: 7271

BLACK LIGHT ACCESSORIES

Black Light Bulbs



Note: The socket base of the 507320 is similar in size to that of a table lamp socket.

100W Medium Base Bulb

- ▶ 100 watt spotlight bulb, replacement for ZB-100 and ZB-100F models and all other MAGNAFLUX 100 watt lamps made after May 1982.

Note: The socket base of the 507320 is similar in size to that of a table lamp socket.

Part #: 507320



100W Ad Medium Base

- ▶ 100W spotlight bulb, replacement for MAGNAFLUX 100W lamps made BEFORE May 1982. Replacement of current Spectronics Lamps.

Note: The socket size of the Ad Medium Base Bulb is larger than that of the Medium base bulb (507320).

Part #: 1914

U-V Absorbing Spectacles



UV-Absorbing Spectacles

- ▶ Reduces eye fatigue from exposure to UV light emission

Part #: 506249

Filters



Smooth Filter Glass

- ▶ For use with ZB-100 and ZB-100F models

Part #: 519227



Fluted Filter Glass

- ▶ Similar to # 519227, but fluted for a more diffused output pattern

Part #: 3901

Mounting Hardware

Side mounts, tabletop assemblies and wall brackets facilitate the use of black lights in a variety of applications.



ZB-100/100F Side-Mount Assembly

- ▶ Bracket mounts on side of horizontal units
- ▶ Movable pivot arms for adjustment of black light
- ▶ Light assembly lifts from fixture for portable use

Part #: 600029



ZB-100/100F Tabletop Mount Assembly

- ▶ Tabletop mount assembly
- ▶ Movable pivot arms for adjustment of black light
- ▶ Light assembly lifts from fixture for portable use

Part #: 600026

Light Meters

All MAGNAFLUX light meters meet major specs, including ASTM E 1417 and ASTM E 1444 and include instructions and certification report.

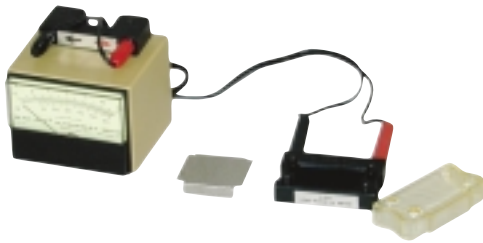

Analog Black Light Meter Model J-221

- ▶ Accurately measures black light intensity (microwatts/cm²)
- ▶ Includes longwave sensor cell, reduction screen contrast filter and extension cord fixture for portable use

Part #: 108254



Digital Meter Model DSE-100X

- ▶ Accurately measures both visible light (footcandles) and black light (microwatts/cm²)
- ▶ Includes digital radiometer/photometer, black light and visible light sensors

Part #: Description:
519567 Meter
519294 Carrying Case



Digital Black Light Meter Model DM-365X

- ▶ Accurate digital readout of black light intensity, tuned at 365 nanometers (microwatts/cm²)
- ▶ Includes meter and black light sensor

Part #: Description:
507522 Meter
519294 Carrying Case

SPECIALTY PRODUCTS



SCRUBS™ In-A-Bucket

Heavy Duty Hand Cleaning!

Revolutionary premoistened hand cleaner towels that go where you go. SCRUBS In-A-Bucket has powerful, yet safe cleaning agents working together with an absorbent, non-scratching abrasive hand cleaner towel. Contains emollients that condition and soften your hands.

Scrubs work well to remove stains from your hands when working with...

- ▶ Liquid Penetrant
- ▶ Grease
- ▶ Magnetic Particle Bath
- ▶ Paint
- ▶ Lubricants
- ▶ Tar
- ▶ Adhesive
- ▶ Sealants, etc.
- ▶ Ink

Part #:
42272

Container Size:
SCRUBS In-A-Bucket Case of 6 Buckets

P-1A Partek – Fluorescent Material for Porous Materials

Specifically for porous materials (i.e., unfired clay ware, sintered metallic compacts, concrete and certain fired ceramics). P-1A is used to locate cracks open to the surface in porous materials.

Part #:	Container Size:
01-8114-40	5 Gallon Pail
01-8114-45	55 Gallon Drum

Ultra Clear Cleaner

Cleaning solution for Filter Cartridge used in our Ultrafilter and Nanofilter Filtration units. Ultra Clear cleaner is a clear, colorless, odorless, water solution to be used for removing scales and oils in our filter membranes.

Part #:	Container Size:
01-9299-20	1 Gallon Jug

ZAF-2 - Antifoaming Agent

Antifoaming liquid additive

Part #:	Container Size:
01-9410-20	1 Gallon Jug

Foilcheck

Foilcheck is a clear hydrocarbon based penetrant fluid with no added dyes. It readily finds "through porosity" in a wide range of manufactured metallic foils and thin film materials. Foilcheck is safe to use on all aerospace alloys including aluminum, magnesium, steel, nickel and titanium.

Part #:	Container Size:
056C169	55 Gallon Drum

CUSTOMER ASSISTANCE DIRECTORY



Dear Valued Customer:

At MAGNAFLUX, we appreciate our CUSTOMERS above everything else. We want to make it as easy as possible for you to do business with us. This directory allows you to call the right person directly. Just dial 847-657-[XXXX] and enter one of the extensions below. Or contact us at our general phone number if you are unsure of whom to call.

General Number:
847.657.5300

Fax Number:
800.421.1569

MSDS FAX BACK:
847.657.5037

Web Page:
www.magnaflux.com

Literature Requests:
Arvell West, 4646

MEET THE MAGNAFLUX CUSTOMER SERVICE TEAM...

The overall goal of our Customer Service Department is to not only meet our customer's goals and expectations but to exceed them whenever possible.



Susan Rogers
Inside Sales Manager

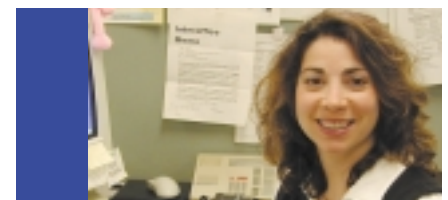

Randi Hurley
Customer Service Representative



Mary Skobel
Customer Service Representative



Al Joseph
Customer Service Representative

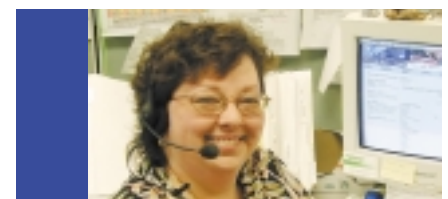

Nancy Buzinskas
International Customer Service Representative

Customer Service

Susan Rogers	5347
<i>Inside Sales Manager</i> rogers@magnaflux.com	
Nancy Buzinskas	5349
<i>Int'l Customer Service Rep.</i> nancy@magnaflux.com	
Randi Hurley	5348
<i>Customer Service Rep.</i> hurley@magnaflux.com	
Al Joseph	5358
<i>Customer Service Rep.</i> joseph@magnaflux.com	
Mary Skobel	5371
<i>Customer Service Rep.</i> mskobel@magnaflux.com	

General Manager

Steve Groeninger	5335
<i>grenny@magnaflux.com</i>	

Materials Department

Vilma Holmgren	5346
<i>Material Business Unit Manager</i> holmgren@magnaflux.com	
Phyllis Doyle	5314
<i>Distributor Manager</i> doyle@magnaflux.com	
Noemi Gonzalez	5331
<i>Int'l Sales Rep.</i> noemigonz@magnaflux.com	
Kathie Green	5330
<i>Marketing Coordinator</i> green@magnaflux.com	
Cheri Stockhausen	5378
<i>Technical Service Specialist</i> cheri@magnaflux.com	
Kevin Walker	5376
<i>Materials Product Manager</i> walker@magnaflux.com	

Equipment Department

Jim Rieger	4722
<i>Equipment Business Unit Manager</i> rieger@magnaflux.com	
Iris Colon	5302
<i>Technical Service Specialist</i> colon@magnaflux.com	
Paul Dunnwald	563.927.9302
<i>Service Manager</i> paul@itwmanchester.com	
Gary Oria	5345
<i>ZYGLO Equipment Product Manager</i> garyoria@aol.com	
Marcin Sekscinski	5362
<i>Application Engineer</i> marcin@magnaflux.com	

Sales

Tim Harz	4274
<i>National Sales Manager, Northeast Territory</i> tjharz@magnaflux.com	
Ken Boden	6167
<i>Regional Sales Manager, Southeast Territory</i> boden@magnaflux.com	
Phil Hansen	4231
<i>Regional Sales Manager, Southwest Territory</i> hansen@magnaflux.com	
Kimberly Hayes	4970
<i>Regional Sales Manager, West Coast</i> hayes@magnaflux.com	
Jim Kemp	4971
<i>Regional Sales Manager, Ohio Valley</i> kemp@magnaflux.com	

Accounting

Lynn Broaddus	4082
<i>Controller</i>	
Cheryl Tantillo	4150
<i>Accounts Receivables</i>	